











In-Line Fans

1 - 27

TD  2 - 7	VENT  8 - 11	IBF  12 - 16	CVAB/CVAT  17 - 18	DH  19 - 20	RH  21 - 22
Accessories					
 RCS 23	 DF 24	 DFK... +EU 25	 ACOP PL 26	 CAR 27	



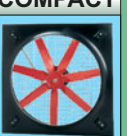









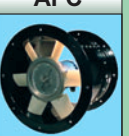

Axial-flow Fans Wall Versions

29 - 42

HXM  30	COMPACT  31 - 39	AFW  40 - 42
---	--	--

Axial-flow Fans Cased Versions

43 - 69

COMPACT  44 - 51	TCB □x2  52 - 53	AFC  54 - 57	AFC-VB  58 - 59	AFC-HT  60	AFD  61 - 62	AFH  63 - 64	AFS  65 - 66
AFK  67	Accessories						
	 Louvre shutters	 Flexible connectors	 Sleeve	 Mounting base	 Protection net		

Roof Fans

71 - 86

RF  72 - 74	RFV  75 - 76	RBH  77 - 78	CTH..., CTV...  79 - 85	Accessories  86
---	--	--	---	---

Fans "ATEX"

87 - 94

EGM  88 - 91	COMPACT EXE  92	HDT, HDB  93 - 94
--	---	---

Centrifugal Fans VISP/VASP

95 - 104

VISP

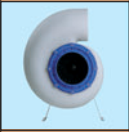

96 - 99

VASP



100 - 103

Accessories



104

Centrifugal Fans

105 - 190

SEM



106

DEM



107

CBM



108 - 110

CBP



111 - 114

GSF-AP HT



115 - 116

GSF

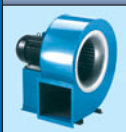

117 - 119

GRF



120 - 121

GSFG



122 - 125

MPB



126 - 129

MPR



130 - 132

MPT



133 - 137

Accessories

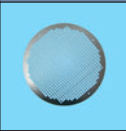

138 - 139

GMT



140 - 143

GSB/MSB

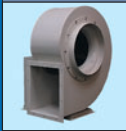

144 - 149

MSB-VB



150 - 152

HSB

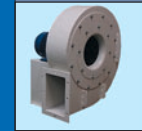

153 - 155

GST



156 - 158

QP



159 - 161

Q



162 - 165

Q-2



166 - 167

DPB



168 - 169

FCM

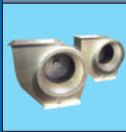

170

RL



170

PB



171

PH



171

BL



172

BFN



172

HPBx



173 - 175

HPB, HPT, HPR

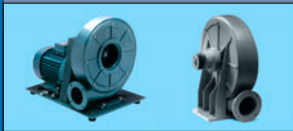

176 - 188

Accessories



189 - 190

Side Channel Blowers

191 - 212

SC



192 - 200

SC VB



201 - 204

DSC/PSC



205 - 210

Accessories



211 - 212

Chip Extractors

213 - 215

WNF



214 - 215

Domestic Fans

217 - 227

SILENT



218 - 219

DECOR



220 - 221

EDM



222 - 223

EBB, EB



224

EBB, EB N



225

TDM

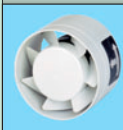

226

HTB



227

Accessories

229 - 232

RMB



230

REB-1 NE



230

REGUL-2



230

HIG-2



231

SQA



231

CT 12/14



231

Commander SK



232

Electric Diagrams

233 - 237

General Information

239 - 242

Index

243 - 244

All fans in this catalogue can be specified with orientations as shown below. However some fans can only be delivered as shown in the pictures in the catalogue. The symbols show the fan from the drive side or the motor side.

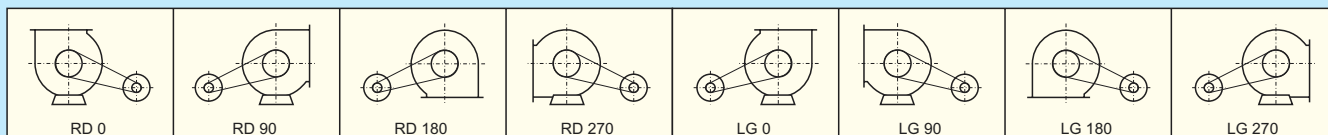

Performance curves are valid with a tolerance of $\pm 10\%$ for the pressure and $\pm 10\%$ for the airflow, air density $1,223\text{kg/m}^3$, at an ambient temperature of 20°C and at 1013mbar atmospheric pressure. We reserve the right to make changes of constructions and performance curves without prior notice. We do not take any responsibility for misprints.

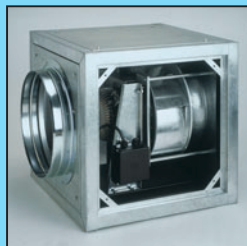

TD	2
VENT	8
IBF	12
CVAB/CVAT	17
DH	19
RH	21
RCS	23
DF	24
DFK... + EU	25
ACOP PL	26
CAR	27

In-Line Fans

Axial-flow Fans Wall Versions

Axial-flow Fans Cased Versions

Roof Fans

Fans "ATEX"

Centrifugal Fans VISP/VASP

Centrifugal Fans

Side Channel Blowers

Chip Extractors

Domestic Fans

Accessories

Electric Diagrams

General Information

Index



Construction

TD - the new generation of In-Line fans suit 6 different standard ducts (Ø100-400mm). Max flow 5100m³/h and max pressure 950Pa. The TD-fans are suitable for close-installation to ceilings, walls and to joists and they also are aesthetical attractive. The TD-fans can be horizontal or vertical installed.

The TD-fans can easily be dismantled for cleaning and service by loosen 2 binding clips without affecting the ducting.

The switch connector is mounted on the outside for easy electrical installation. TD-160, 250, 350, 500 and TD-800 have casing in reinforced plastic, TD-1000, 1300, 2000, 4000 and TD-6000 have casing in painted steel sheet. TD-160, 250, 350, 500 and TD-800 have impellers made of tough ABS plastic, TD-800N, 1000, 1300 2000, 4000 and TD-6000 have impellers made of aluminium sheet. All impellers are easy to dismount.



Motor

TD-160, 250 and TD-350:

220-240V, 50Hz single-phase asynchronous motor with built in fuse in the winding. Enclosure IP44. The motors are equipped with sleeve bearings and wined for 2 speeds, i.e. with a two-pole switch, one high speed (HF) and one low speed (LF) is obtained.

TD-500, 800, 1000, 1300 and TD-2000:

220-240V, 50Hz single-phase asynchronous motor with built in thermal protection (manually reset thermal contact can be supplied). Enclosure IP44. The motors are equipped with ball bearing and wined for 2 speeds, i.e. with a two-pole switch, one high speed (HF) and one low speed (LF) is obtained.

TD-4000 and TD-6000:

220-240V, 50Hz single-phase asynchronous motor with built in thermal protection (manually reset thermal contact can be supplied). Enclosure IP44. The motors are equipped with ball bearing.

Wiring diagram, see page 234.

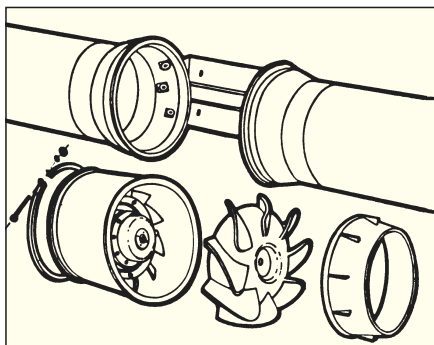

Accessories

The TD-fans can be equipped with following:

- 2 speed switches
- Electronic regulator for variable speed control

Accessories



Duct filter DF page 24



Duct filter DFK page 25



Duct heater DH page 19



Backdraught shutter CAR page 27



Ativib. coupling ACOP PL page 26



Speed switch REGUL-2 page 230



Speed control REB page 230



Speed control RMB page 230



Humidistat HIG-2 page 231



Air quality sensor SQA page 231



Thermostat TS, TK page 231

Model numbering system

TD - 800 / 200 N

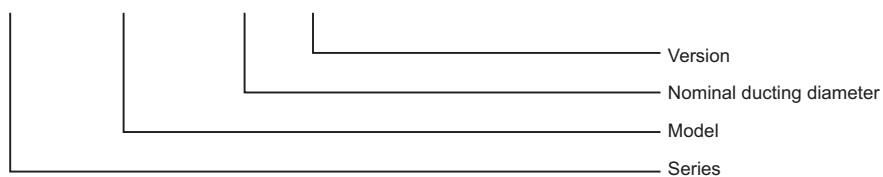

Data

Type	Speed Rpm	Maximum power absorbed W	Maximum current A	Maximum duty m ³ /h	Maximum temperature °C	Sound level dB (A)	Weight kg	Article number
TD-160/100	2500 (HS) 2200 (LS)	35 16	0,16 0,10	180 160	-20 +40	29 26	1,4	112202061
TD-250/100	2200 (HS) 1850 (LS)	24 18	0,11 0,10	240 180	-20 +40	31 26	2,0	112202065
TD-350/125	2250 (HS) 1900 (LS)	30 22	0,13 0,10	360 280	-20 +40	33 28	2,0	112202073
TD-500/150 160	2500 (HS) 1950 (LS)	50 44	0,22 0,19	580 430	-40 +60	33 29	2,7	112202104 112202102
TD-800/200N	2780 (HS) 2480 (LS)	70 60	0,30 0,26	880 700	-40 +60	37 33	4,9	112202153
TD-800/200	2500 (HS) 2000 (LS)	120 100	0,50 0,45	1100 800	-40 +60	39 33	4,9	112202152
TD-1000/250	2800(HS) 2610(LS)	125 85	0,50 0,35	1010 900	-40 +60	40 38	9,4	112202201
TD-1300/250	2520 (HS) 2000 (LS)	180 140	0,80 0,60	1300 1100	-40 +60	43 39	9,4	112202221
TD-2000/315	2700 (HS) 2000 (LS)	255 160	1,20 0,80	2000 1550	-40 +60	47 42	14,0	112202251
TD-4000/355	1400	345	1,53	3800	-20 +40	44	19,0	112202240
TD-6000/400	1400	665	2,97	5500	-20 +40	44	26,0	112202260

Performance curves

HS - High speed

LS - Low speed

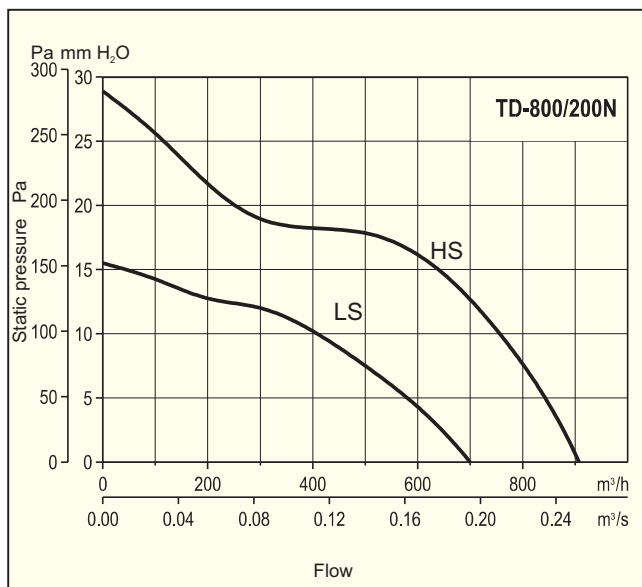
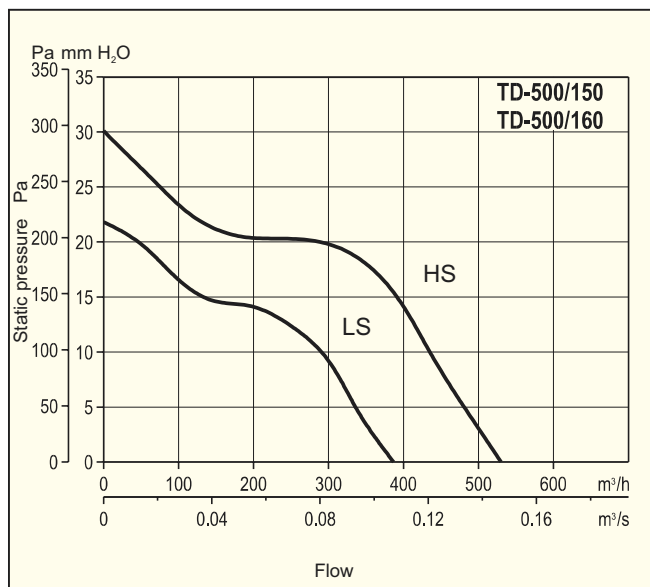
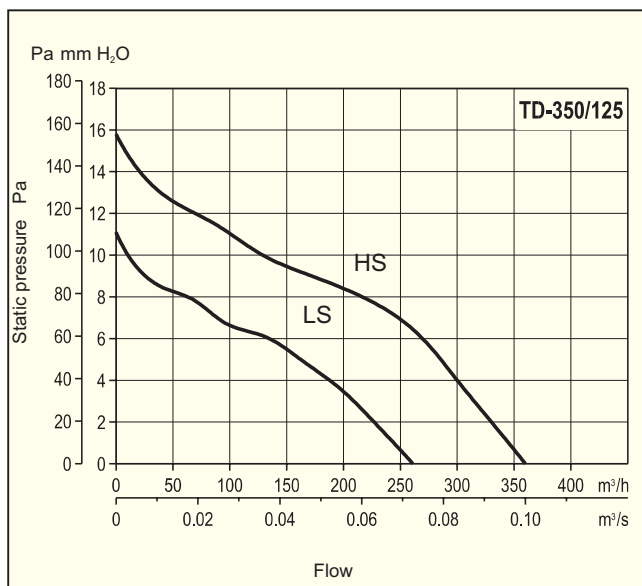
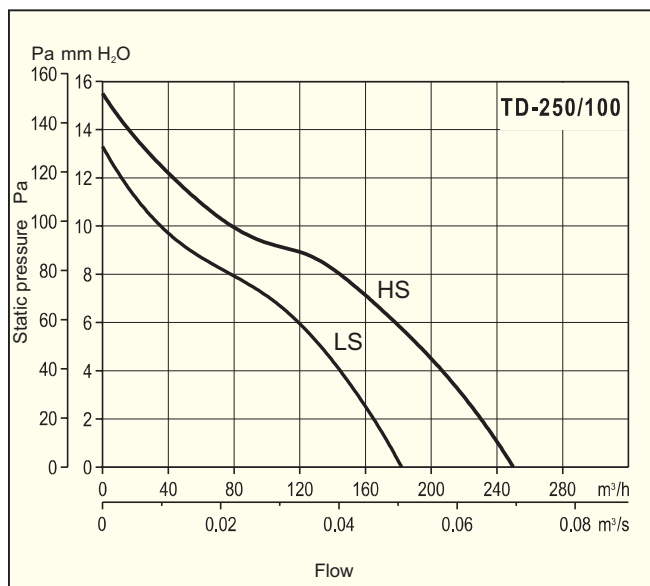
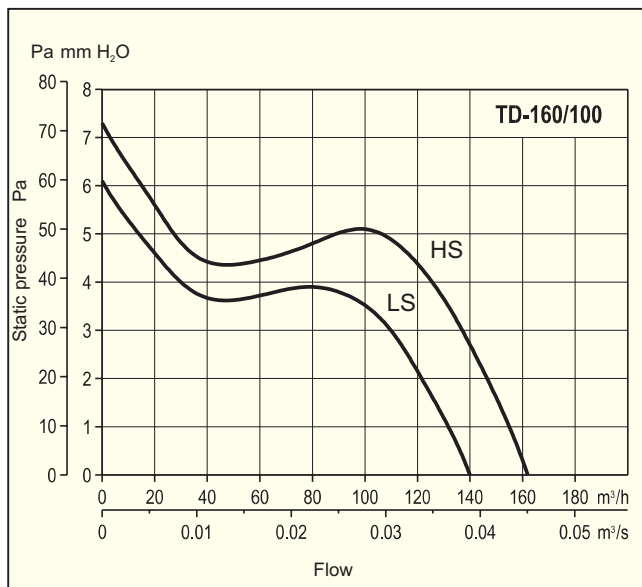

Performance curves

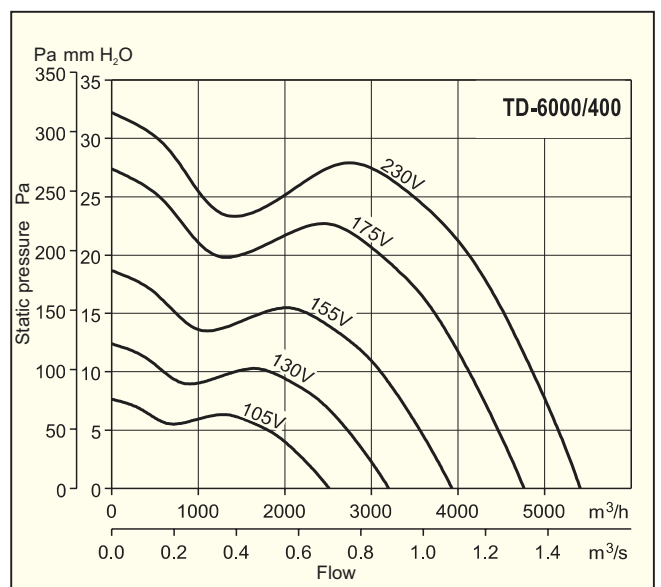
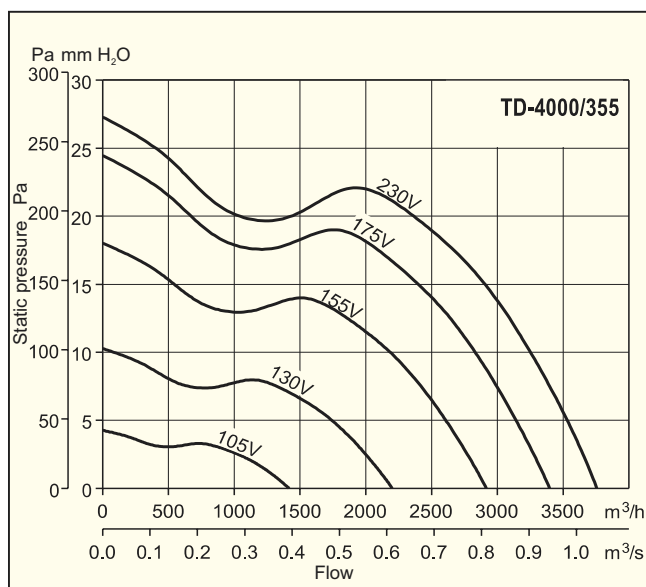
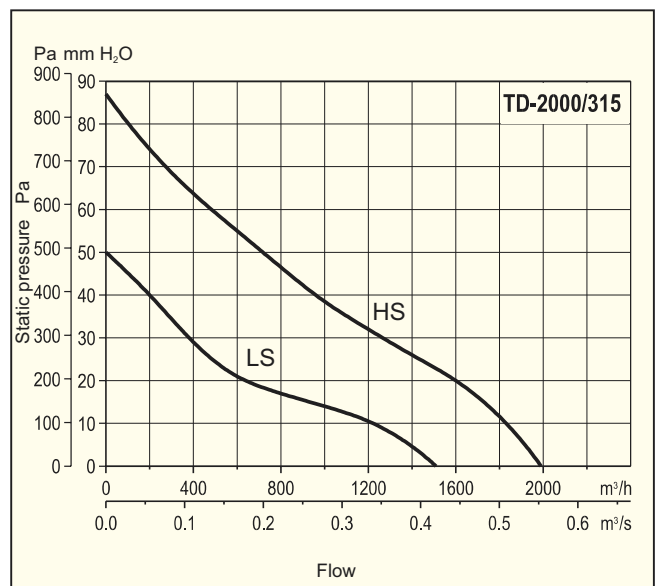
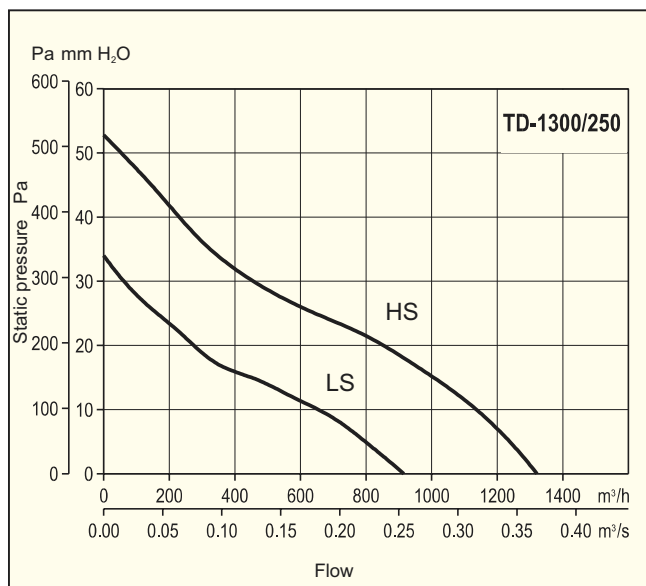
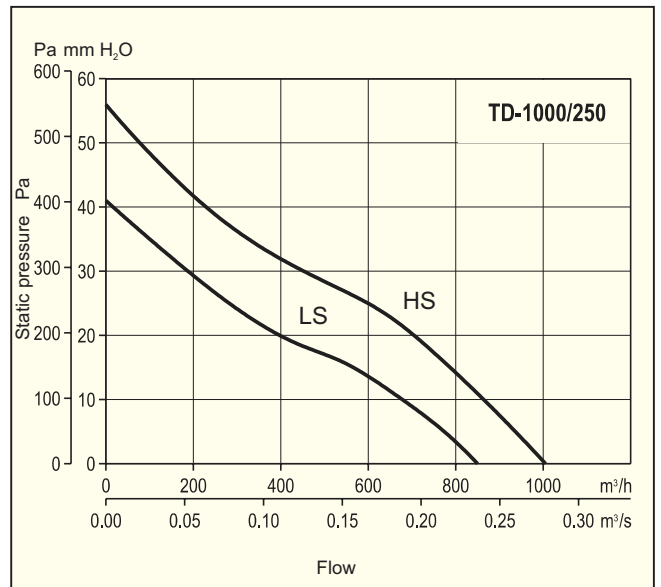
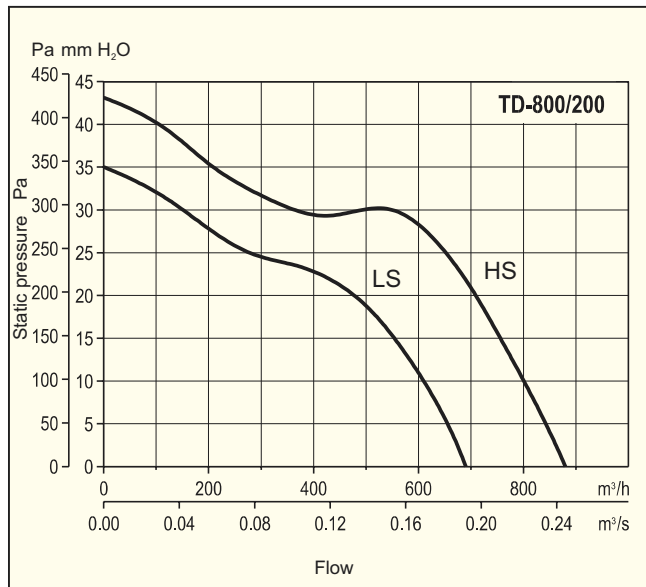

Dimensions in mm

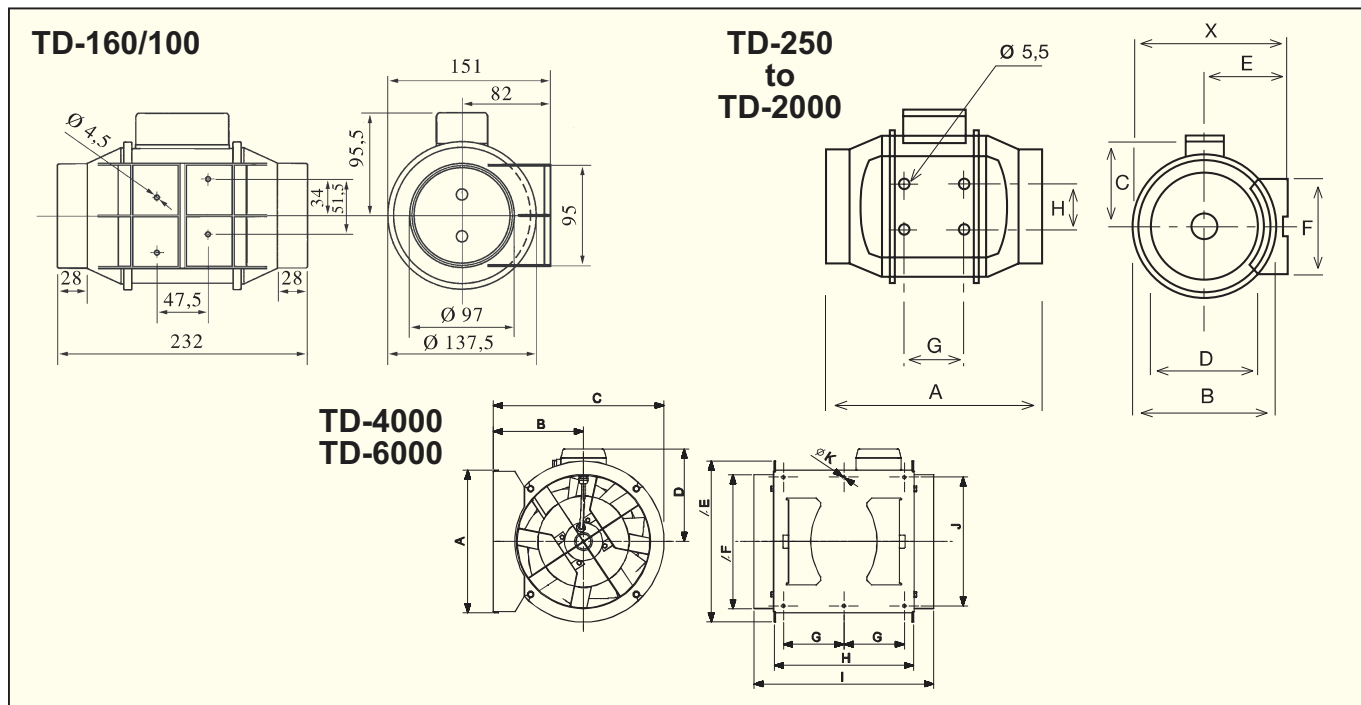

Type	X	A	ØB	C	ØD	E	F	G	H
TD-250/100	188	303	176	115	97	100	90	80	60
TD-350/125	188	258	176	115	123	100	90	80	60
TD-500/150	212	295	200	127	147	112	130	80	60
TD-500/160	212	275	200	127	157	112	130	80	60
TD-800/200N	232,5	302	217	141	198	124	140	100	94
TD-800/200	232,5	302	217	141	198	124	140	100	94
TD-1000/250	291	386	272	192	248	155	168	145	140
TD-1300/250	291	386	272	192	248	155	168	145	140
TD-2000/315	356	450	336	224	312	188	210	182	178

Type	A	B	C	D	ØE	ØF	G	H	I	J	ØK
TD-4000/355	377	238	451	224	426	354	150	368	474	340	8,5
TD-6000/400	407	249	492	267	487	399	160	425	547	370	8,5

Construction

		160	250	350	500	800	800N	1000	1300	2000	4000	6000
Casing	polipropylene	•	•	•	•	•	•					
	steel							•	•	•	•	•
Impeller	ABS	•	•	•	•	•						
	aluminium						•	•	•	•	•	•
Electrical insulation		II	II	II	II	II	II	I	I	I	I	I
Thermal overload protection	fuse type	•	•	•								
	automatic				•	•	•	•	•	•	•	•
Ball bearings		•	•	•	•	•	•	•	•	•	•	•
Speed control	1-speed										•	•
	2-speed	•	•	•	•	•	•	•	•	•		

Acoustic performance characteristics

Sound power level spectrum (dB (A)) at octave average frequencies (Hz), measured at fan discharge.

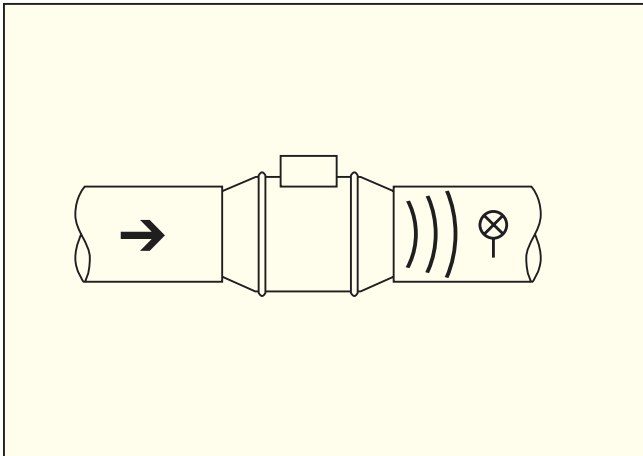

Frequency dB (A) \ Hz	63	125	250	500	1000	2000	4000	8000
TD-160/100	30	30	39	49	52	42	37	27
TD-250/100	28	47	46	53	52	47	39	33
TD-350/125	35	47	46	53	54	50	41	33
TD-500/150	32	35	55	57	59	62	56	48
TD-500/160	32	35	55	57	59	62	56	48
TD-800/200N	37	42	62	64	66	64	60	52
TD-800/200	37	47	61	63	68	67	64	54
TD-1000/250	35	45	58	66	72	69	62	54
TD-1300/250	37	52	64	67	75	73	66	61
TD-2000/315	41	57	66	71	77	74	67	62
TD-4000/355	40	49	61	66	73	70	66	57
TD-6000/400	43	56	67	72	76	74	69	60

Acoustic power level spectrum (dB (A)) at octave average frequencies (Hz), measured outside fan casing.

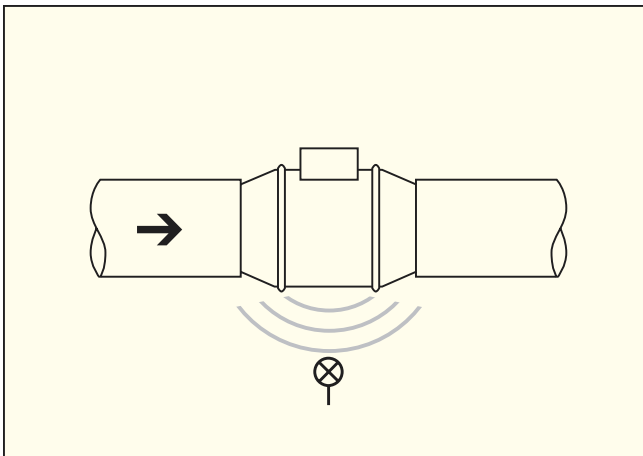

Frequency dB (A) \ Hz	63	125	250	500	1000	2000	4000	8000
TD-160/100	30	29	37	47	43	39	33	24
TD-250/100	27	46	45	44	43	43	32	25
TD-350/125	33	46	46	47	47	45	33	24
TD-500/150	25	32	43	39	44	53	42	29
TD-500/160	25	32	43	39	44	53	42	29
TD-800/200N	26	32	48	47	52	53	44	31
TD-800/200	29	36	47	46	54	57	48	33
TD-1000/250	23	34	44	46	58	57	46	43
TD-1300/250	22	36	39	47	60	59	52	47
TD-2000/315	29	41	52	55	64	63	57	53
TD-4000/355	31	49	55	55	63	57	51	40
TD-6000/400	30	53	59	55	61	55	54	45

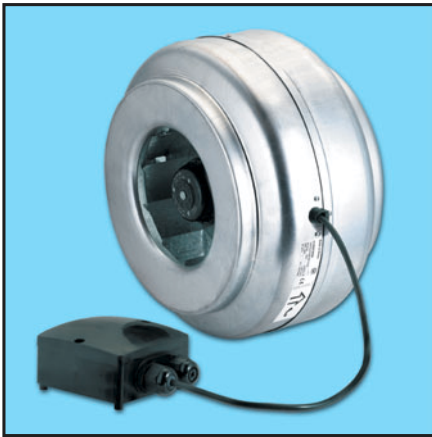

VENT 100 to VENT 315

Construction

In-Line fans designed for circular ducting Ø100 to Ø315mm. Casing in galvanized steel sheet, impeller with backward curved blades. Balanced according to ISO 1940.

Motor

Single-phase, external rotor motor with ball bearing, 220-240V, 50/60Hz with permanent capacitor, self-resetting thermal protection and jack panel. Enclosure IP44, insulation class B.

VENT-355L-T and VENT-400L-T has three phase motor with ball bearings, 230/400V, 50/60Hz.

Wiring diagram, see page 236.



VENT 355 and VENT 400

Accessories



Duct filter
DF
page 24



Duct filter
DFK
page 25



Duct heater
DH
page 19



Backdraught
shutter CAR
page 27



Antivib. coupling
ACOP PL
page 26



2-speed switch
REB
page 230



Speed controller
RMB
page 230



Humidistat
HIG-2
page 231



Air quality sensor
SQA
page 231



Thermostat
TS, TK
page 231

Technical specification

Type	Voltage V	Speed rpm	Maximum power W	Maximum current A	Maximum duty m³/h	Sound pressure level* dB(A)	Maximum temperature °C	Weight kg	Article number
VENT-100B	230	2100	48	0,22	235	38	40	3	112 208 103
VENT-100L	230	2500	78	0,33	290	47	60	3	112 208 101
VENT-125B	230	1900	44	0,21	280	39	40	3	112 208 107
VENT-125L	230	2450	80	0,35	410	47	60	3	112 208 105
VENT-150B	230	2100	70	0,30	560	46	60	5	112 208 132
VENT-150L	230	2700	120	0,53	700	50	60	5	112 208 130
VENT-160B	230	2200	70	0,30	600	45	60	5	112 208 112
VENT-160L	230	2750	130	0,55	760	51	60	5	112 208 110
VENT-200B	230	2250	125	0,50	830	47	60	5	112 208 117
VENT-200L	230	2600	170	0,72	1000	52	60	5	112 208 115
VENT-250B	230	2300	130	0,55	935	49	60	6	112 208 122
VENT-250L	230	2750	180	0,80	1100	54	60	6	112 208 120
VENT-315B	230	2300	235	1,00	1440	52	50	8	112 208 127
VENT-315L	230	2700	350	1,45	1890	55	50	8	112 208 125
VENT-355L	230	1350	280	1,20	2650	60	40	17	112 208 135
VENT-400L	230	1250	400	1,60	3380	61	40	22	112 208 140
VENT-355L-T	230/400	1375	290	1,4/0,8	2650	60	40	17	112 208 137
VENT-400L-T	230/400	1360	450	1,9/1,1	3380	61	40	22	112 208 142

* - 3m distance with fan ducted.

Acoustics performance characteristics

Type	LwA	63	125	250	500	1000	2000	4000	8000	TOT
100L	inlet	44	53	63	60	67	61	52	41	70
	outlet	42	48	67	61	63	61	55	44	70
	radiated	42	44	53	51	46	45	40	33	56
100B	inlet	37	43	54	49	59	54	48	39	61
	outlet	38	42	56	48	53	53	49	38	60
	radiated	36	33	32	36	40	38	34	26	45
125L	inlet	38	47	59	67	65	62	56	44	70
	outlet	38	45	61	64	63	63	56	46	69
	radiated	37	43	45	51	47	45	42	33	54
125B	inlet	33	43	55	57	57	55	51	41	62
	outlet	34	41	57	53	55	56	52	41	62
	radiated	34	36	35	38	41	39	37	28	46
150L	inlet	40	45	63	73	69	64	61	46	75
	outlet	40	45	63	66	67	64	61	47	72
	radiated	40	37	46	59	51	50	43	30	60
150B	inlet	36	44	58	70	64	60	56	40	71
	outlet	36	43	55	62	62	59	56	40	67
	radiated	36	38	40	53	46	45	41	29	55
160L	inlet	39	45	63	74	70	67	63	48	77
	outlet	43	45	61	67	68	65	62	49	72
	radiated	43	36	44	60	52	51	45	32	61
160B	inlet	35	41	56	69	63	60	56	42	71
	outlet	35	42	54	63	61	59	57	42	67
	radiated	35	37	37	52	45	45	42	29	54

Type	LwA	63	125	250	500	1000	2000	4000	8000	TOT
200L	inlet	42	52	63	70	69	68	66	60	75
	outlet	43	51	63	70	69	69	68	59	75
	radiated	43	48	40	51	53	52	49	39	58
200B	inlet	41	53	60	67	66	64	63	52	72
	outlet	42	51	61	65	66	66	65	53	72
	radiated	42	42	34	46	48	53	46	37	56
250L	inlet	43	57	67	71	72	70	70	60	78
	outlet	42	53	67	73	75	75	72	62	80
	radiated	36	52	37	53	53	51	50	38	59
250B	inlet	42	53	62	68	69	66	66	57	74
	outlet	39	48	62	70	70	69	67	59	76
	radiated	38	43	36	52	48	50	48	42	56
315L	inlet	45	58	70	74	75	76	71	66	81
	outlet	57	58	72	76	77	77	72	68	83
	radiated	51	54	49	56	61	59	56	48	65
315B	inlet	44	59	68	70	71	70	67	60	77
	outlet	44	51	71	72	75	74	69	64	80
	radiated	43	43	47	50	52	55	53	43	59
355L	inlet	40	57	68	71	71	67	59	48	76
	outlet	42	59	62	69	70	68	60	50	74
	radiated	41	55	43	50	55	51	42	29	59
400L	inlet	42	61	69	72	67	66	63	50	76
	outlet	47	63	66	70	69	68	64	51	75
	radiated	45	58	45	52	52	50	46	30	61

Performance curves

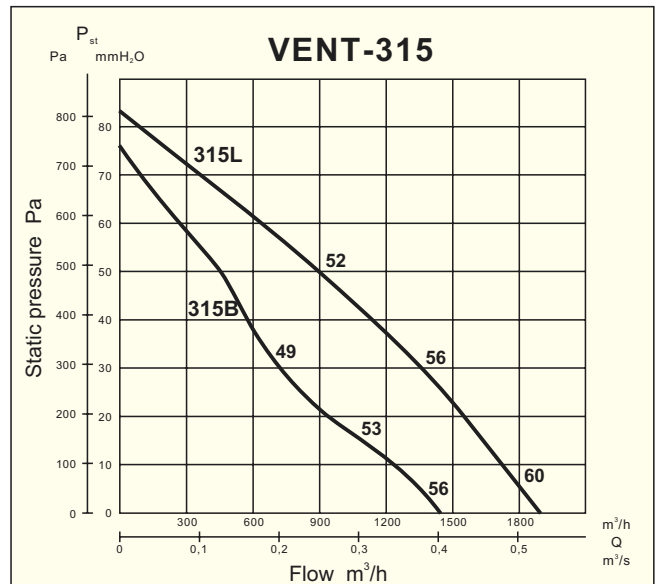
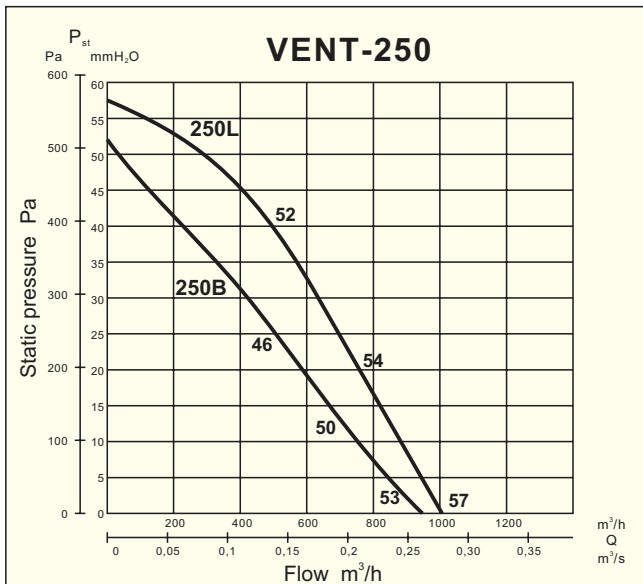
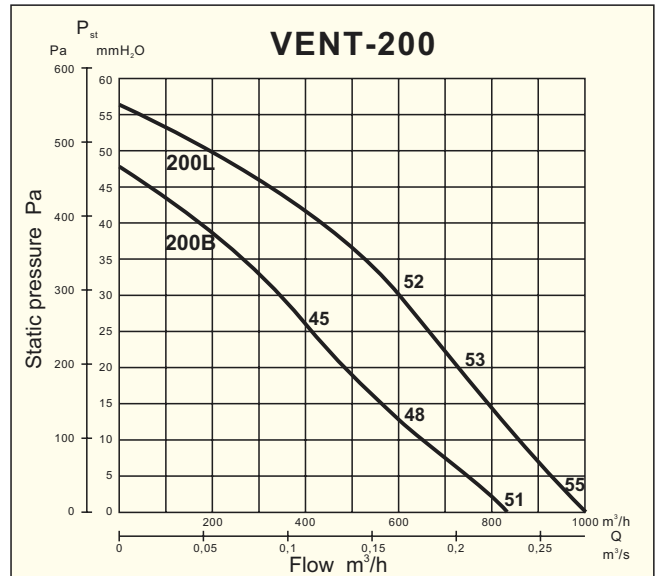
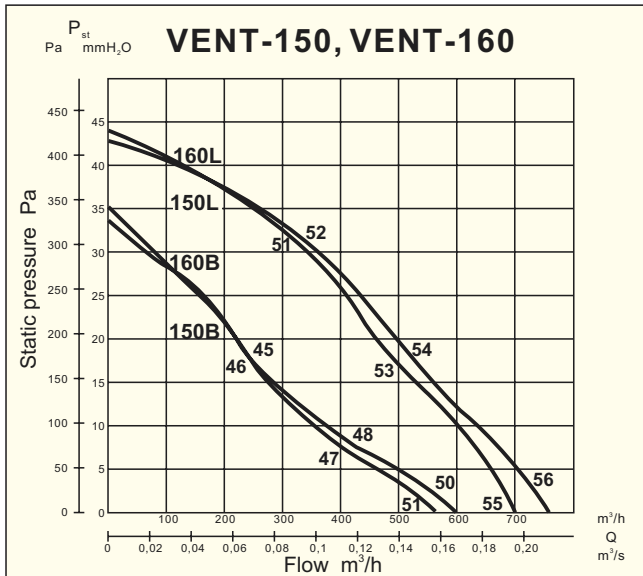
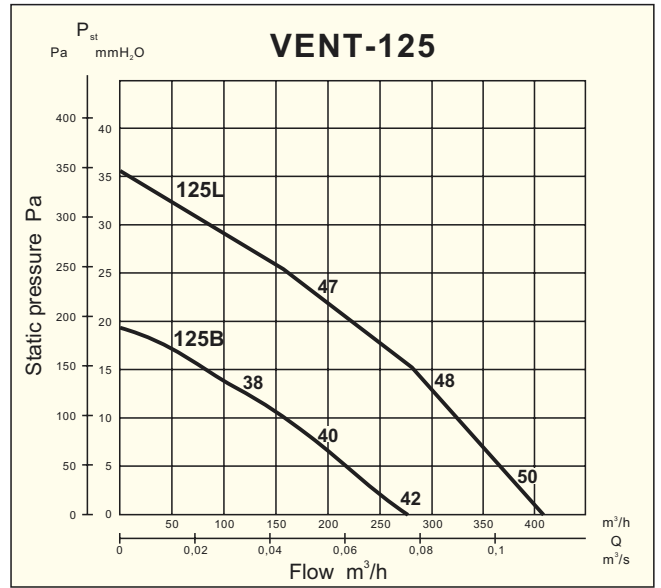
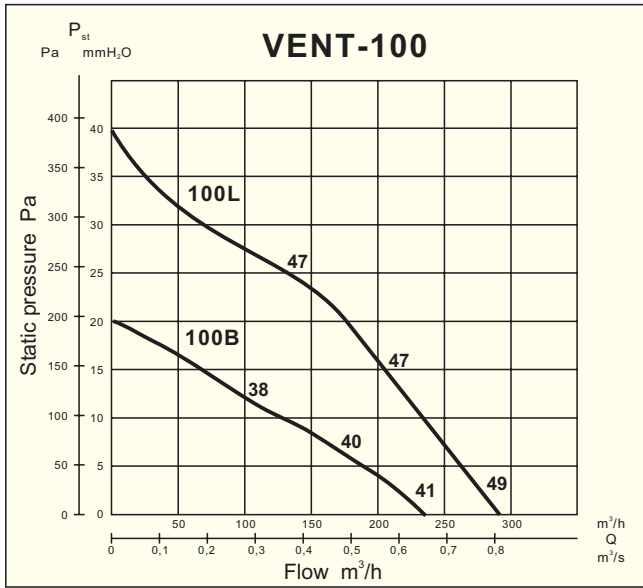

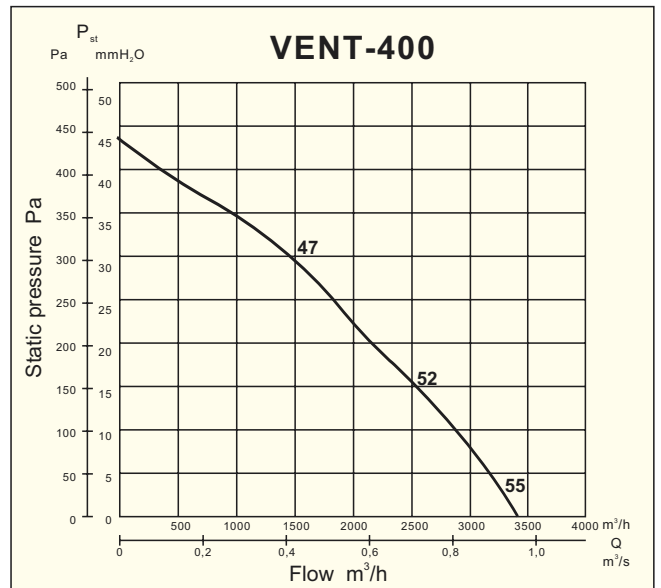
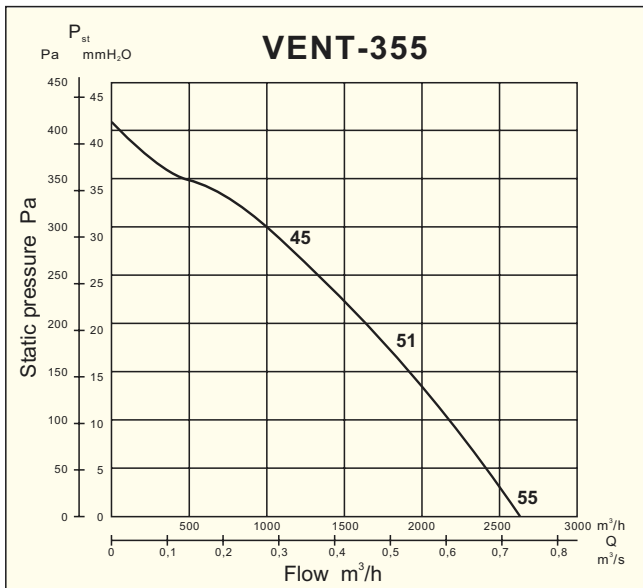

Dimensions in mm

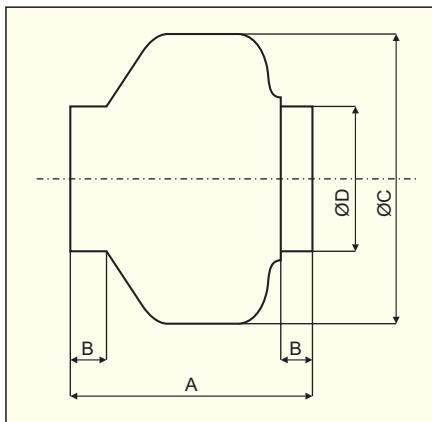

Type	A	B	ØC	ØD
VENT-100	194	23	243	98
VENT-125	195	27	243	123
VENT-150	214	24	333	147
VENT-160	222	28	333	157
VENT-200	223	25	333	198
VENT-250	206	27	333	248
VENT-315	230	25	401	312

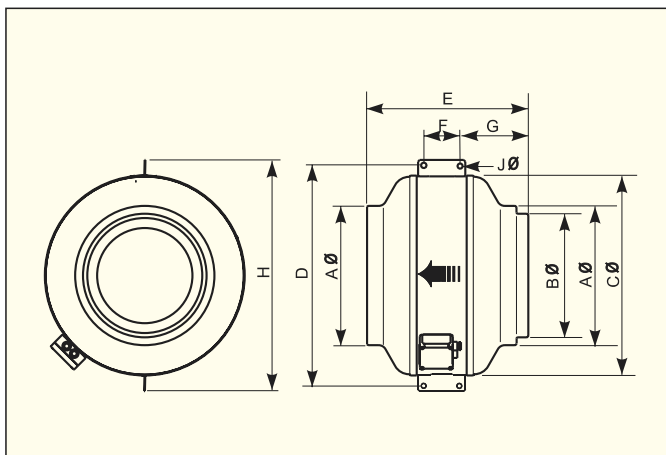

Type	A	B	C	D	E	F	G	H	J
VENT-355	354	314	508	583	410	100	170	587	10,5
VENT-400	399	354	568	623	441	100	185	647	10,5



Construction

In-line fan designed for installation in rectangular ducting. Casing in welded steel sheet, powder coated. Backward curved impellers.

Motor

220-240V, 50Hz single-phase external rotor motor with capacitor suitable for speed control or 400V, 50Hz three phase. Enclosure IP44, insulation class B. Special voltage or frequency improved enclosure and motors with thermal protection may be supplied on request.

Wiring diagram, see page 236.



Dimensions in mm

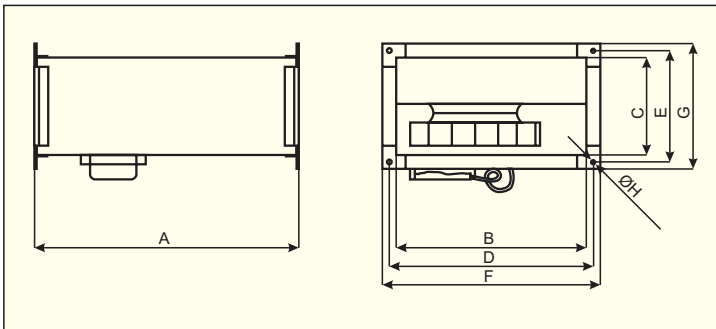

Type	A	B	C	D	E	F	G	ØH
190	402	298	148	320	170	340	190	9
220	502	398	198	420	220	440	240	9
280	532	498	248	520	270	540	290	9
315	565	500	298	522	320	540	338	9
355	725	600	348	622	370	640	388	9
400	725	600	348	622	370	640	388	9
450	725	700	400	722	422	740	440	9
500	880	800	500	822	522	840	540	9
560	1000	1000	500	1022	522	1040	540	9

Accessories



Electronic regulator REB page 230



Speed controller RMB page 230



Duct heater RH page 21



Silencer RCS page 23

Data

Type	Motor power W	Speed rpm	Voltage V	Maximum current A	Maximum duty m³/h	Maximum pressure Pa	Sound pressure level dB(A)	Weight kg	Article number
IBF/2-190	85	2400	230	0,34	600	300	64	7,5	113921100
IBF/2-220	110	2790	230	0,53	900	400	71	12	113921200
IBF/2-280	260	1850	230	1,1	1500	540	76	16	113921300
IBF/4-280	90	1400	230	0,4	1000	150	61	15,5	113921400
IBF/4-315S	120	1440	230	0,56	1400	230	66	22	113921500
IBF/4-355S	230	1400	230	1,16	2250	270	68	33	113921600
IBF/6-315S	47	965	230	0,18	1050	120	51	22	113921550
IBF/6-355S	66	875	230	1,16	1700	140	55	33	113921650
IBF/4-315T	120	1400	400	0,48	1400	230	66	22	113921560
IBF/4-355T	230	1400	400	1,1	2250	270	68	33	113921660
IBF/4-400S	520	1355	230	2,2	4050	380	78	35	113921670
IBF/4-400T	460	1345	400	0,85	4050	380	78	35	113921680
IBF/6-400S	160	880	230	1,6	2750	170	67	35	113921690
IBF/6-400T	160	890	400	0,36	2750	170	67	35	113921700
IBF/4-450S	740	1280	230	3,2	5500	440	83	85	113921710
IBF/4-450T	690	1230	400	1,3	5500	440	83	85	113921720
IBF/6-450S	240	840	230	1,05	3800	210	74	85	113921730
IBF/6-450T	250	880	400	0,6	3800	210	74	85	113921740
IBF/4-500S	1300	1320	230	5,7	7800	600	83	122	113921750
IBF/4-500T	1200	1320	400	2,2	7800	600	83	117	113921760
IBF/6-500S	380	820	230	1,65	5150	250	73	110	113921770
IBF/6-500T	390	850	400	0,81	5150	250	73	110	113921780
IBF/4-560T	1800	1230	400	3,41	10200	690	88	155	113921790
IBF/6-560S	670	810	230	3	7500	300	78	155	113921800
IBF/6-560T	690	850	400	1,5	7500	300	78	150	113921810

Performance curves

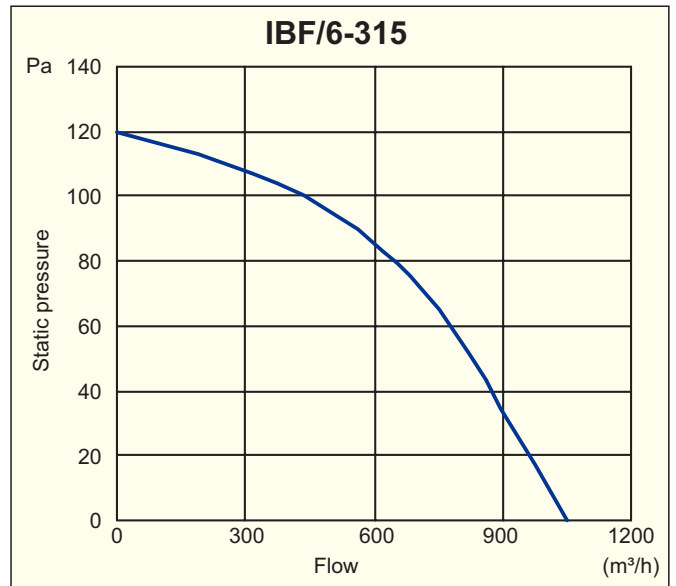
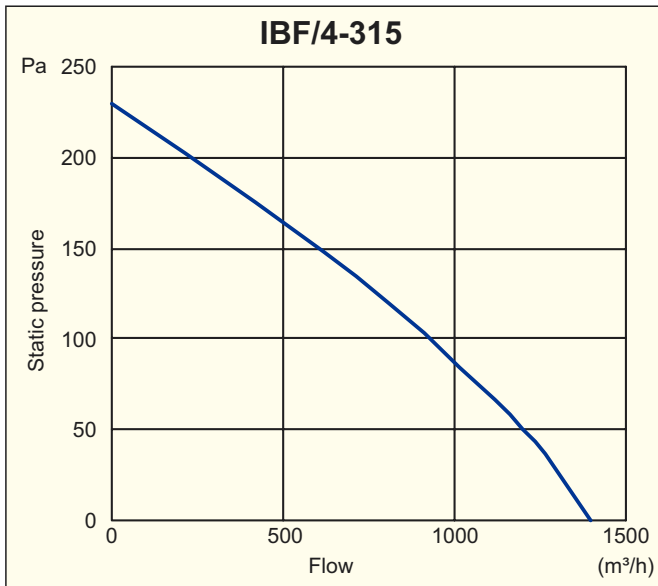
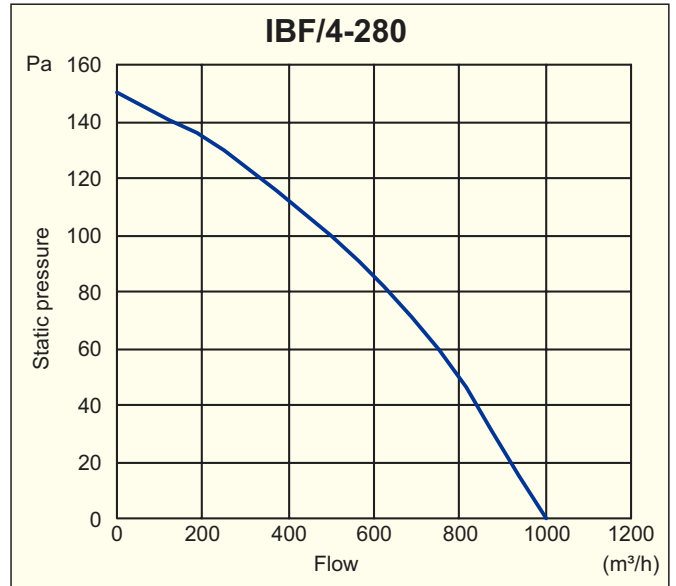
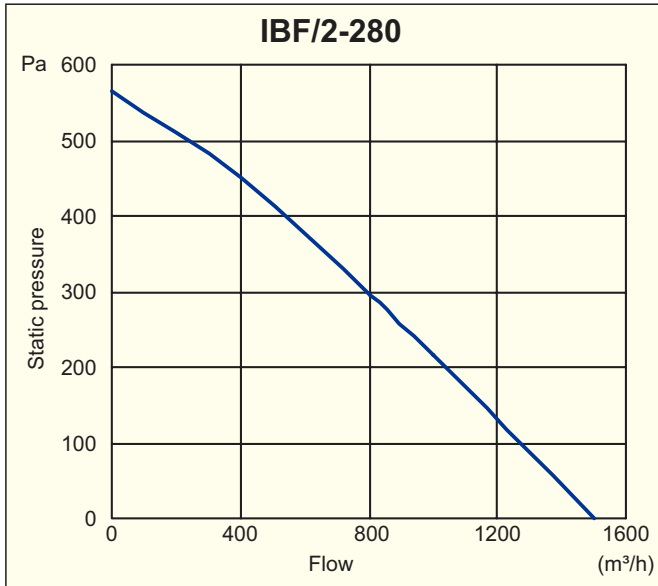
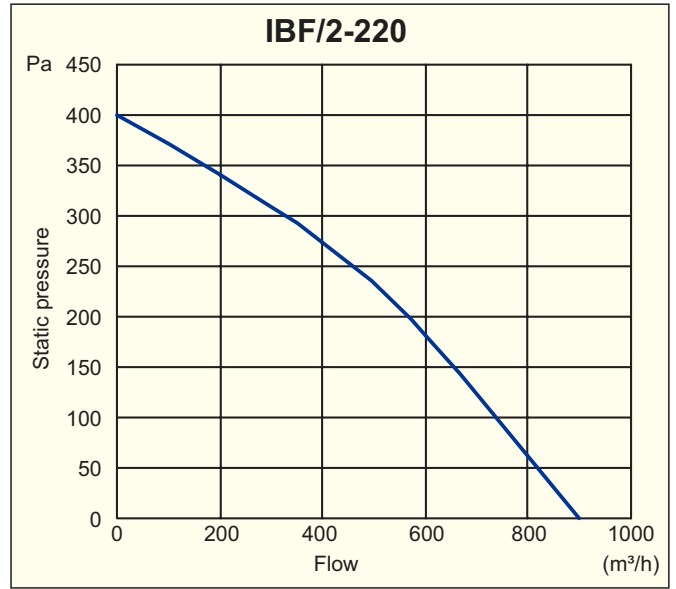
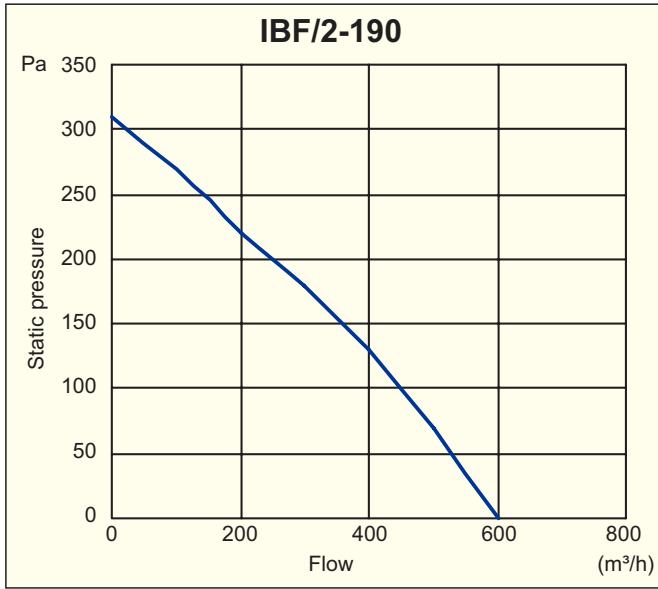

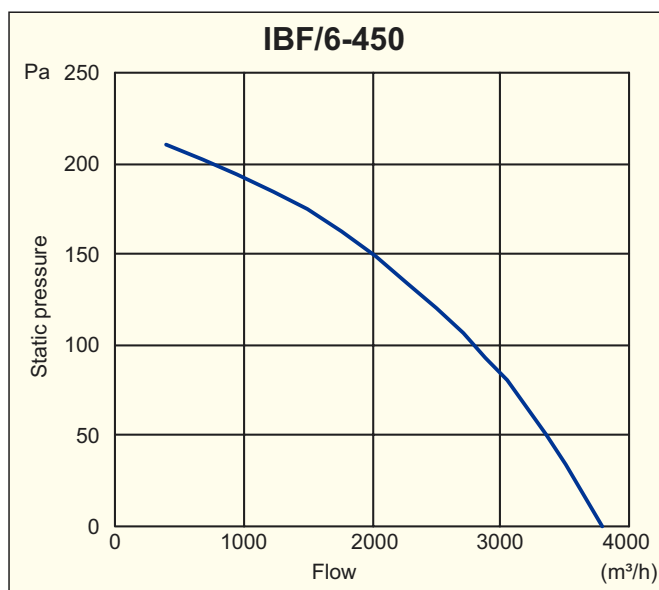
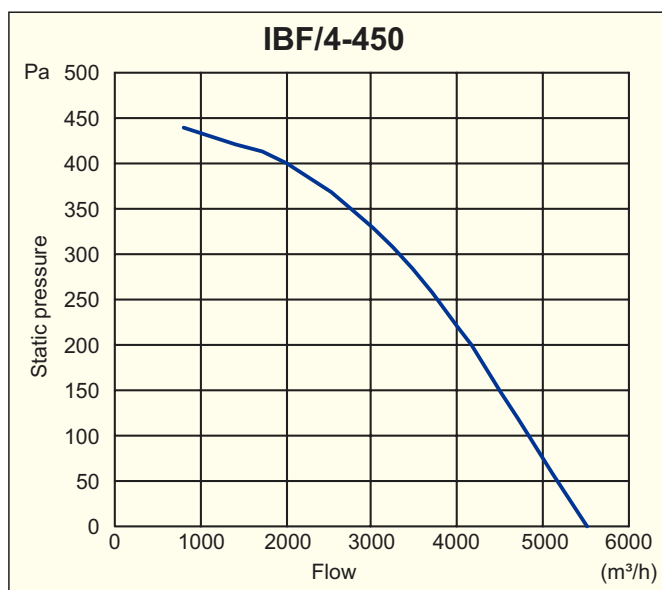
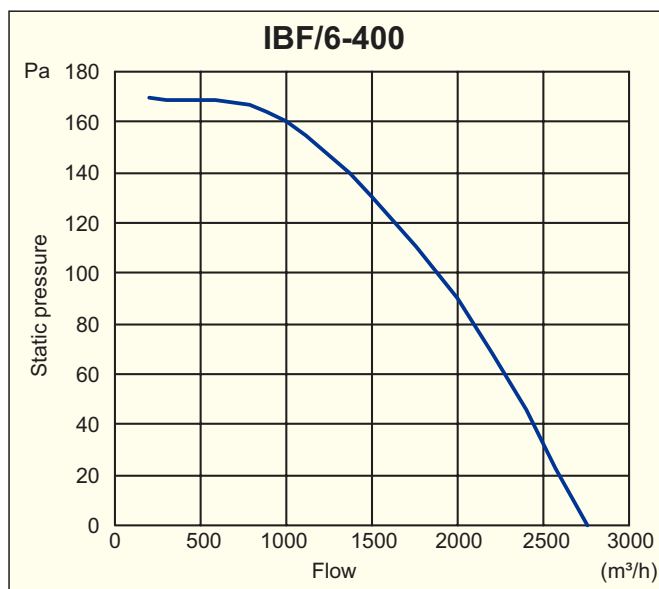
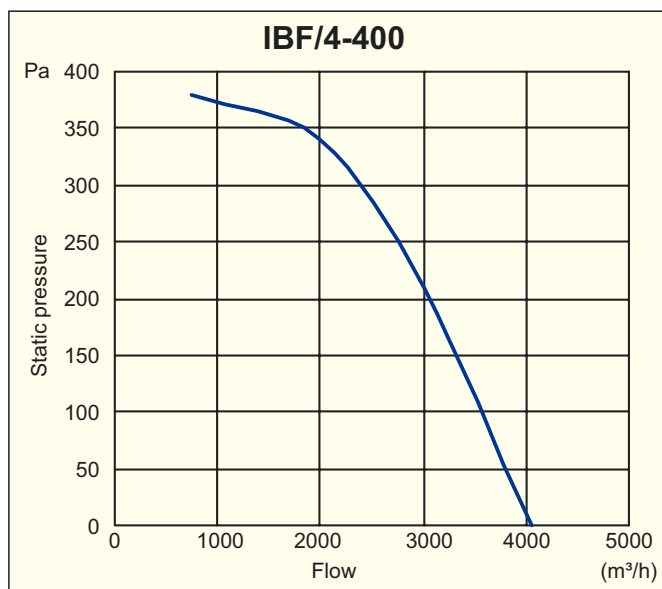
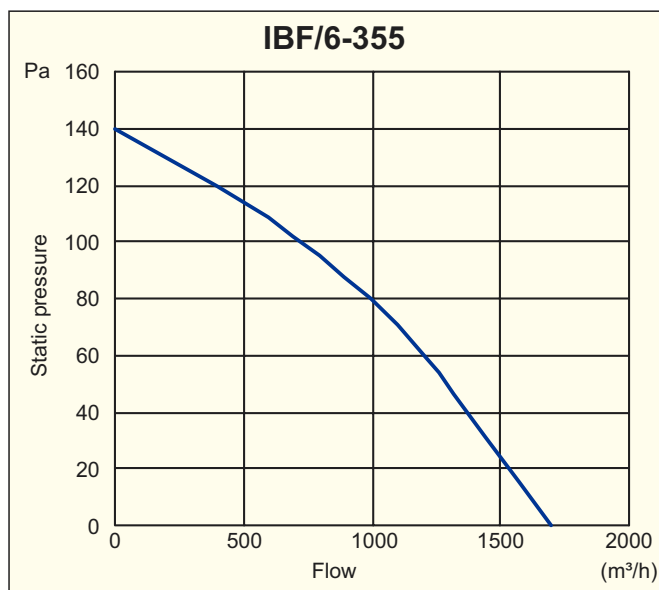
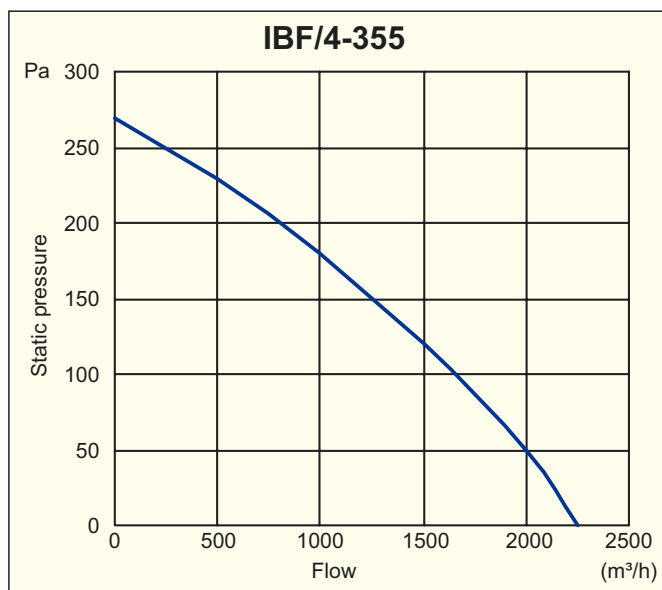

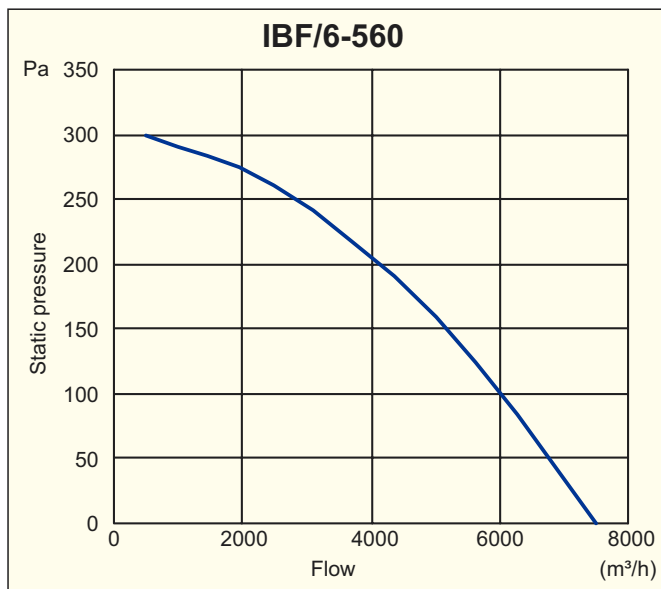
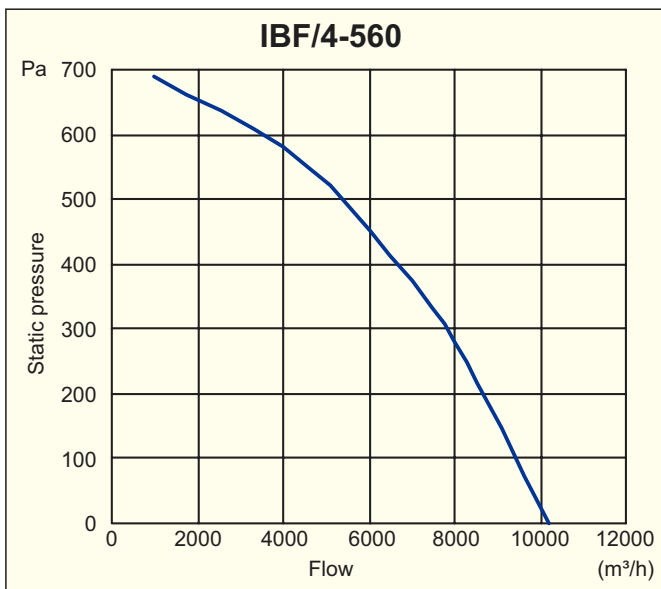
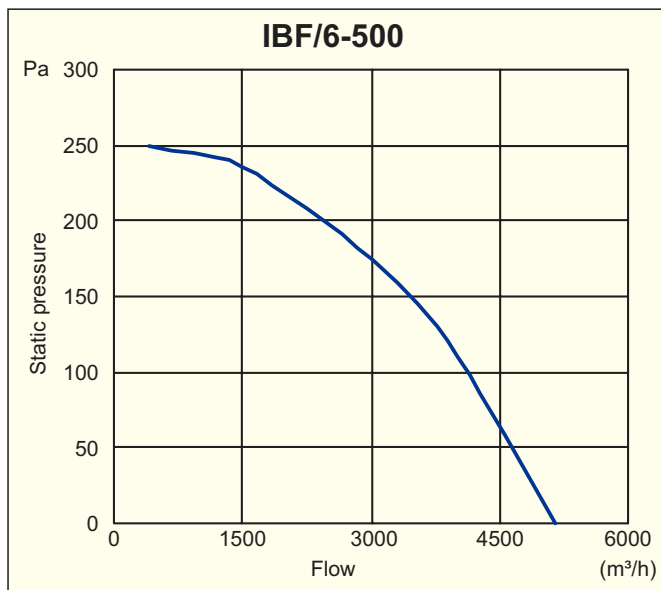
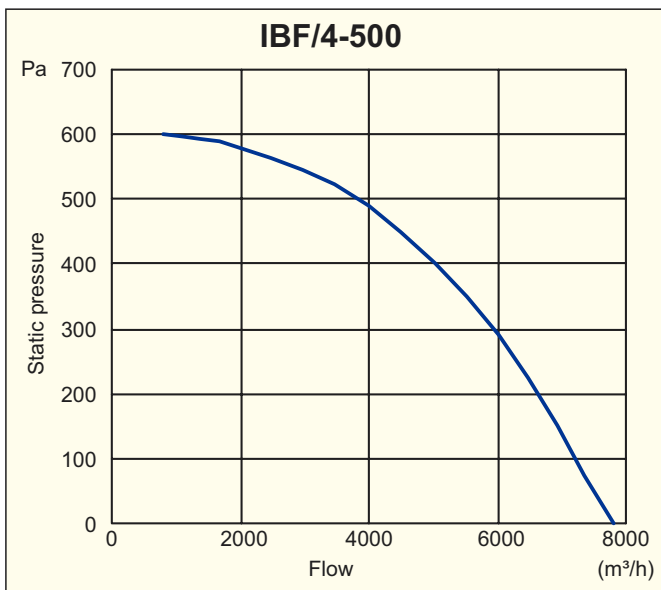

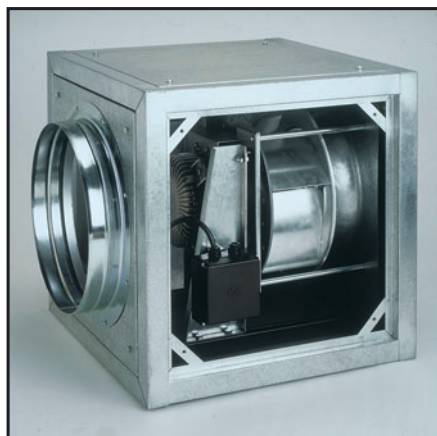

Construction

In-line fan designed for installation in circular ducting from Ø200 to Ø710 mm. Insulated casing in galvanized steel sheet. Impeller in galvanized steel sheet with backward curved blades. Dynamic balanced according to ISO 1940.

Motor

220–240V, 50Hz single-phase or 230/400V, 50Hz three phase asynchronous motor, thermal protection with terminals of the thermal trip are brought out to the terminal box. Enclosure IP55 according to UNE 20–11 and IEC 34–5 (waterproof, dustproof design), insulation class F for environmental temperature +70°C. The motor is designed according to IEC 34–1 and dynamically balanced according to ISO 1940. Speed controllable by variation of the supply voltage by means of transformer or electrical regulator. Special voltage or frequency and improved enclosure can be supplied on request.

Wiring diagram, see page 235.

Technical specification

Type	Speed rpm	Motor power W	Maximum current A		Maximum duty m ³ /h	Sound level* dB (A)			Weight kg	Article number
			230V	400V		Outlet	Inlet	Radiated		
SINGLE-PHASE										
CVAB/4-700/200	1375	62	0,30	-	690	46	44	32	26	112 208 415
CVAB/4-1200/250	1340	115	0,57	-	1150	51	47	35	30	112 208 418
CVAB/4-1500/250	1380	160	0,72	-	1520	54	52	42	38	112 208 421
CVAB/4-2600/355	1350	275	1,20	-	2600	60	55	42	46	112 208 425
CVAB/4-3800/355	1380	570	2,60	-	3750	63	60	48	62	112 208 428
CVAB/4-5600/400	1380	1100	5,30	-	5600	70	66	52	94	112 208 431
THREE-PHASE										
CVAT/4-700/200	1375	62	-	0,17	690	46	44	32	26	112 208 435
CVAT/4-1200/250	1340	115	-	0,35	1150	51	47	35	30	112 208 438
CVAT/4-1500/250	1380	160	-	0,50	1520	54	52	42	38	112 208 441
CVAT/4-2600/355	1350	275	-	0,80	2600	60	55	42	46	112 208 445
CVAT/4-3800/355	1380	570	-	1,50	3750	63	60	48	62	112 208 448
CVAT/4-5600/400	1380	1100	-	1,80	5600	70	66	52	94	112 208 451
CVAT/4-9000/500	1475	2050	-	4,80	8800	76	75	60	105	112 208 455
CVAT/6-6000/500	960	900	-	3,30	5700	67	65	53	105	112 208 458
CVAT/6-10000/630	975	1500	-	3,90	10000	69	69	53	120	112 208 461
CVAT/6-14000/630	965	2500	-	5,40	14000	74	73	58	160	112 208 465
CVAT/6-17000/710	965	3900	-	6,90	17100	78	76	60	220	112 208 468

* distance 1.5m

Accessories



Duct filter
DF
page 24



Duct filter
DFK
page 25



Duct heater
DH
page 19



Speed switch
REB
page 230



Speed controller
RMB
page 230



Humidistat
HIG-2
page 231



Air quality sensor
SQA
page 231



Thermostat
TS, TK
page 231

Performance curves

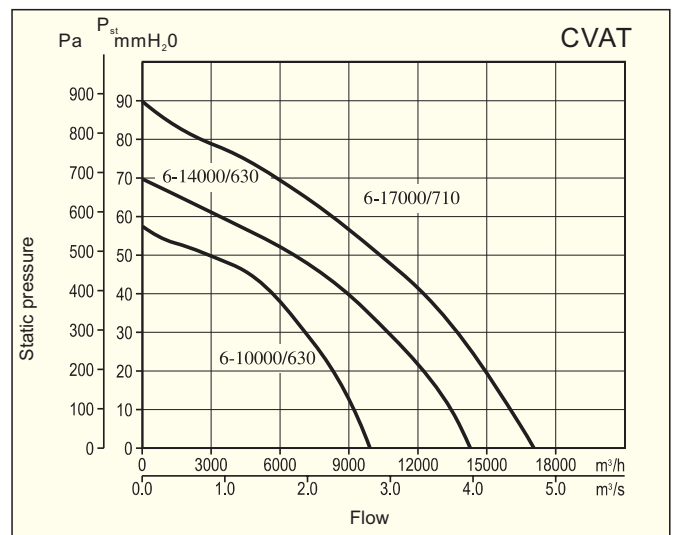
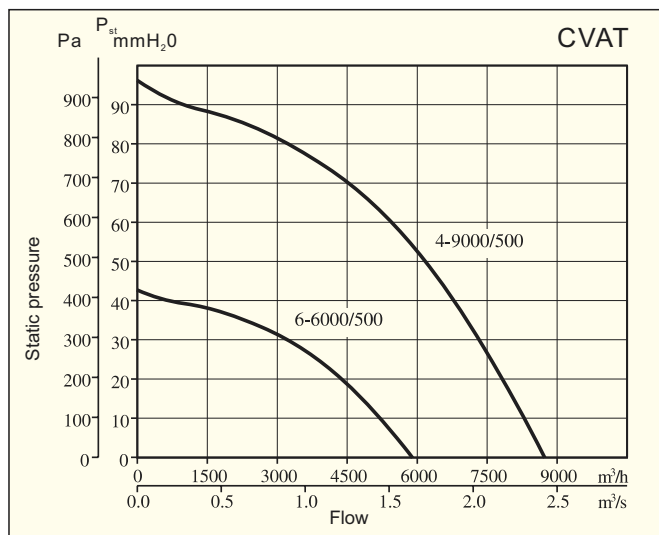
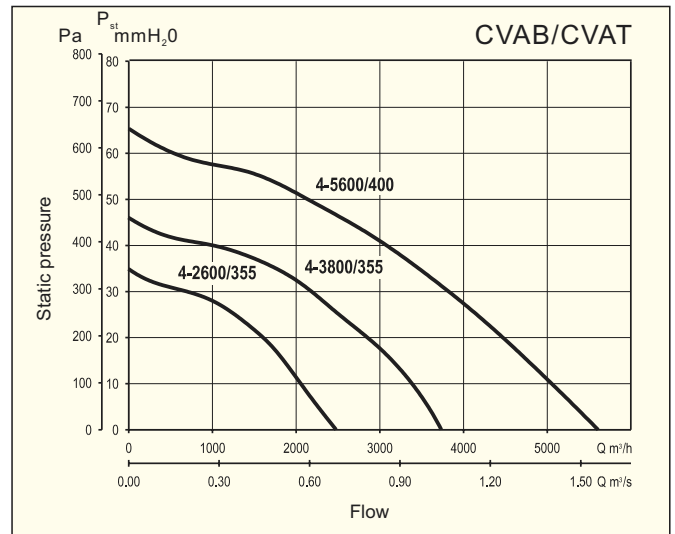
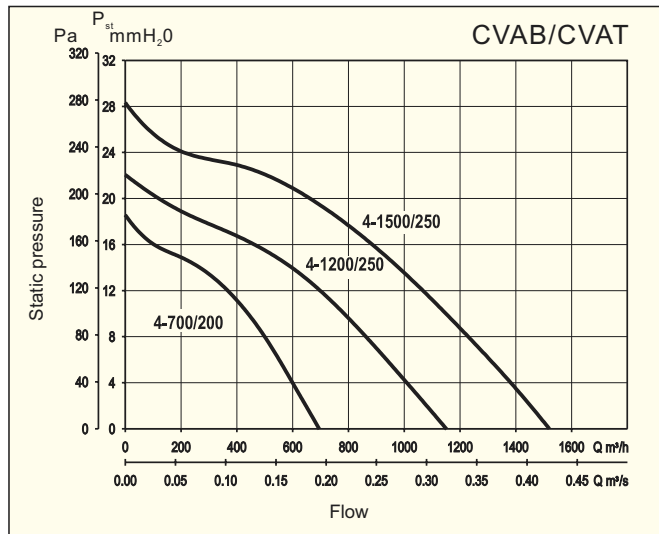

Dimensions in mm

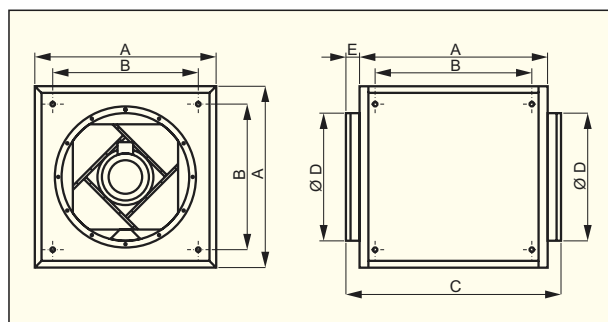

Type	A	B	C	ØD	E
CVA□/4-700/200	400	270	530	200	65
CVA□/4-1200/250	450	320	580	250	65
CVA□/4-1500/250	500	370	630	250	65
CVA□/4-2600/355	550	390	680	355	65
CVA□/4-3800/355	650	490	780	355	65
CVA□/4-5600/400	800	640	930	400	65

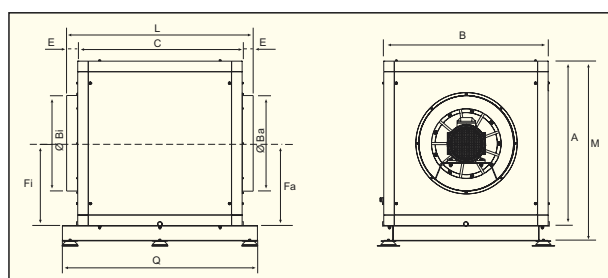

Type	A	B	C	E	L	M	Q	ØBi	ØBa	Fi	Fa
CVAT/4-9000/500	860	860	860	55	970	940	1020	500	500	430	430
CVAT/6-6000/500	860	860	860	55	970	940	1020	500	500	430	430
CVAT/6-10000/630	920	920	920	55	1030	1000	1080	630	630	460	460
CVAT/6-14000/630	980	980	980	55	1090	1060	1140	630	630	490	490
CVAT/6-17000/710	1037	1037	1037	55	1147	1117	1197	710	710	518,5	518,5



Construction

Duct heaters designed for installation directly in ventilation ducts (Ø100 to 400mm). Casing in welded steel sheet, powder coated. The heating elements are designed in stainless material (SS2337). Duct heaters should not be dimensioned for higher outlet temperature than 40°C. The air speed through the heaters should not be lower than 1,5m/s.

Wiring diagram, see page 236, 237.

Model numbering system

DH - 125 / 09

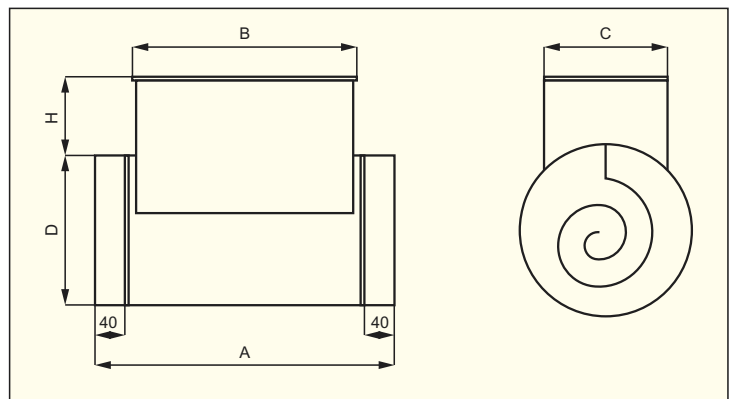
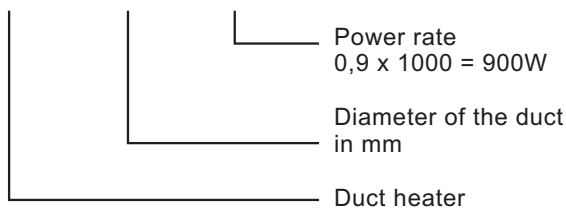

Type	Motor power kW	Voltage V	Dimensions in mm					Number of element rows	Article number
			A	B	C	D	H		
DH-100/03	0,3	230	380	280	98	100	105	1 x 300W	113 981 100
DH-125/09	0,9	230	380	280	105	125	105	3 x 300W	113 981 150
DH-160/15	1,5	230	380	280	135	160	105	3 x 500W	113 981 200
DH-160/20	2,0	230	380	280	135	160	105	4 x 500W	113 981 250
DH-200/20	2,0	230	400	300	165	200	105	4 x 500W	113 981 300
DH-200/30	3,0	3x400	400	300	165	200	105	3 x 1000W	113 981 330
DH-200/45	4,5	3x400	400	300	165	200	105	3 x 1500W	113 981 350
DH-200/60	6,0	3x400	400	300	165	200	105	3 x 2000W	113 981 360
DH-250/30	3,0	3x400	400	300	195	250	75	3 x 1000W	113 981 430
DH-250/45	4,5	3x400	400	300	195	250	75	3 x 1500W	113 981 450
DH-250/60	6,0	3x400	400	300	195	250	75	3 x 2000W	113 981 460
DH-250/90	9,0	3x400	400	300	195	250	75	6 x 1500W	113 981 490
DH-315/30	3,0	3x400	400	300	230	315	75	3 x 1000W	113 981 530
DH-315/45	4,5	3x400	400	300	230	315	75	3 x 1500W	113 981 550
DH-315/60	6,0	3x400	400	300	230	315	75	3 x 2000W	113 981 560
DH-315/90	9,0	3x400	400	300	230	315	75	6 x 1500W	113 981 590
DH-315/120	12,0	3x400	400	300	230	315	75	6 x 2000W	113 981 592
DH-355/60	6,0	3x400	440	340	230	355	75	3 x 2000W	113 981 660
DH-355/90	9,0	3x400	440	340	230	355	75	3 x 3000W	113 981 690
DH-355/120	12,0	3x400	440	340	230	355	75	6 x 2000W	113 981 692
DH-355/150	15,0	3x400	340	230	355	355	75	3x2kW + 3x3kW	113 981 694
DH-400/60	6,0	3x400	340	230	400	400	75	3 x 2000W	113 981 788
DH-400/90	9,0	3x400	440	340	230	400	75	3 x 3000W	113 981 790
DH-400/120	12,0	3x400	440	340	230	400	75	6 x 2000W	113 981 792
DH-400/150	15,0	3x400	440	340	230	400	75	3x2kW + 3x3kW	113 981 795
DH-400/180	18,0	3x400	400	300	230	400	75	6 x 3000W	113 981 797

Accessories



Thermostat
TS, TK
page 231

Selection of duct heater DH

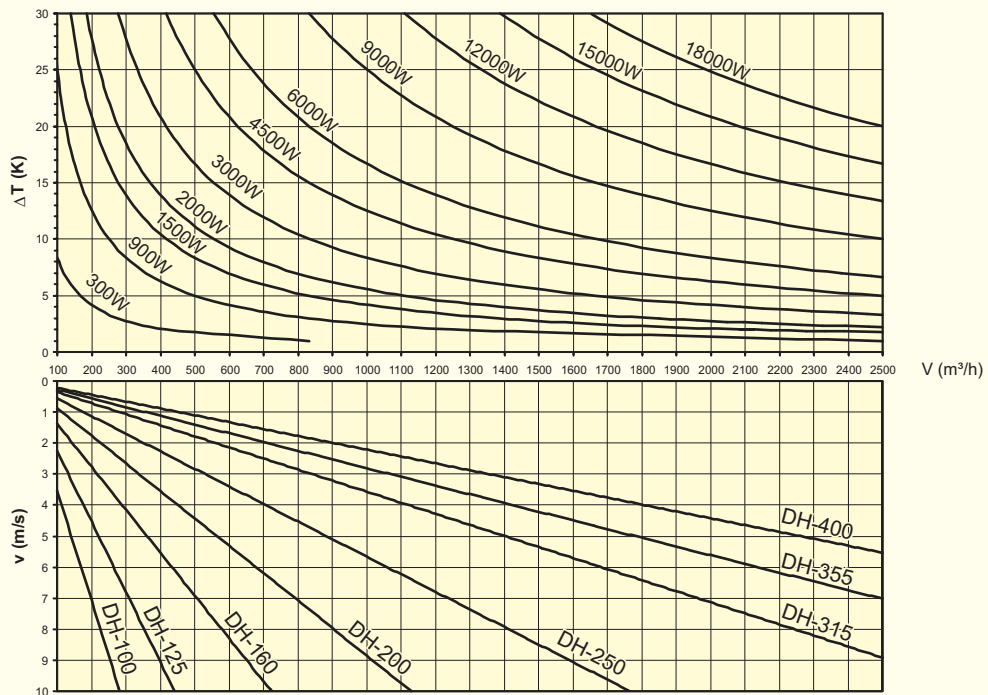

Loss of air pressure through duct heater DH

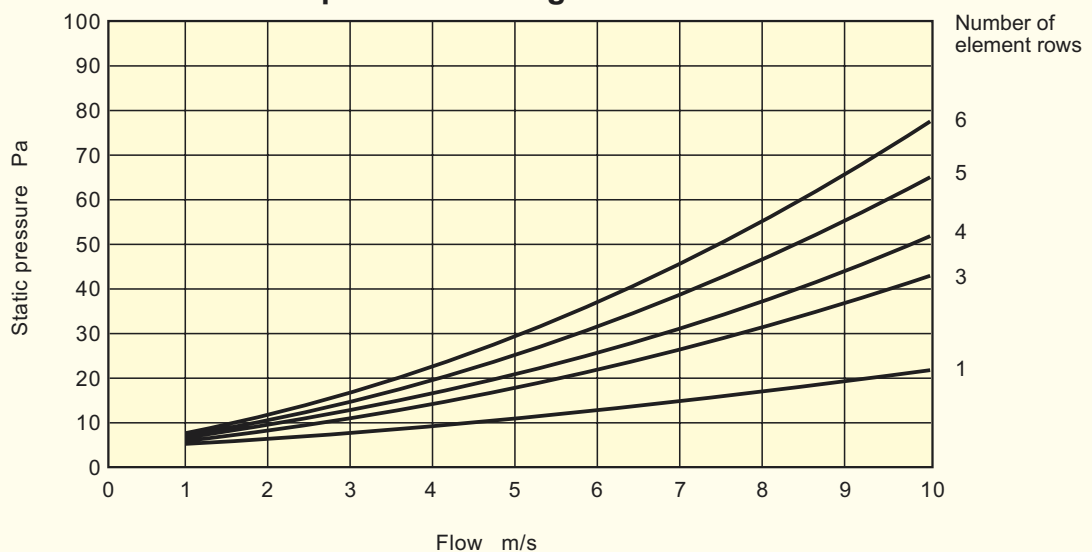

Recommended assembly

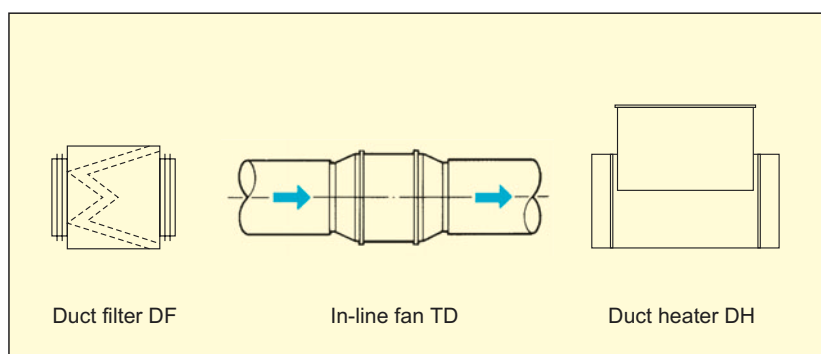

Calculation of power requirement

$$P = Q \cdot 0,36 \cdot \Delta T$$

P - Power [W]

Q - Flow [m³/h]

ΔT - rise in temperature [C]



Construction

Duct heaters designed for installation directly in rectangular ventilation ducts. Casing in welded steel sheet and powder coated. The heating radiators are designed in stainless material (SS2337). Duct heaters have as a standard an automatic and a manual thermal protection. The duct heaters should not be dimensioned for higher outlet temperature than 40°C. The air speed through the heaters should not be lower than 1,5m/s.

Wiring diagram, see page 236, 237.

Model numbering system

RH - 40/20 - 90

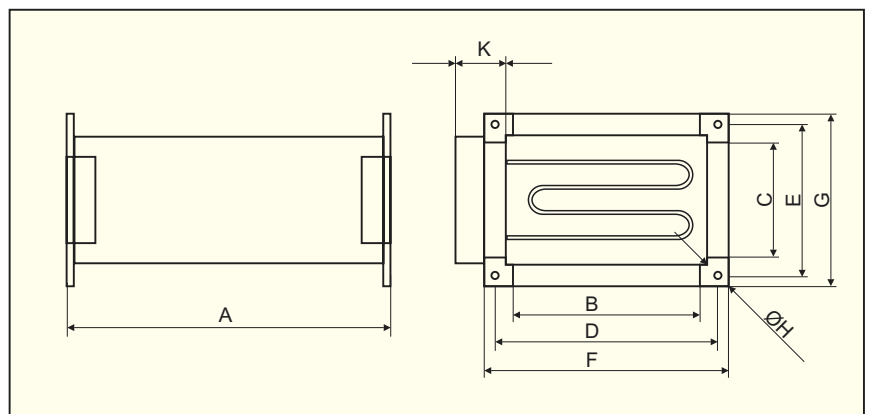
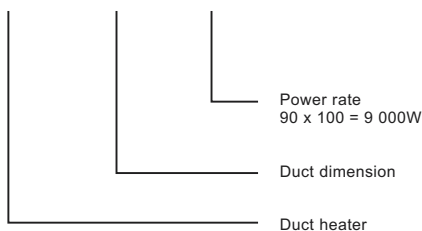

Data

Type	Motor power kW	Voltage V	Dimensions in mm								Number of element rows	Article number	
			A	B	C	D	E	F	G	ØH			K
RH-40/20-45	4,5	3x400	312	398	198	420	220	440	240	9	90	3x1500W	113 982 424
RH-40/20-90	9,0	3x400	502									6x1500W	113 982 425
RH-50/25-90	9,0	3x400	322	498	248	520	270	540	290	9	90	6x1500W	113 982 525
RH-50/25-180	18,0	3x400	532									6x3000W	113 982 528
RH-50/30-135	13,5	3x400	532	500	298	522	320	540	338	9	90	3x3000W+3x1500W	113 982 537
RH-50/30-180	18,0	3x400	532	500	298	522	320	540	338	9	90	6x3000W	113 982 538
RH-60/35-225	22,5	3x400	682	600	348	622	370	640	338	9	90	3x1500W+6x3000W	113 982 635
RH-60/35-270	27,0	3x400	682	600	348	622	370	640	388	9	90	9x3000W	113 982 638

Accessories



Thermostat
TS, TK
page 231

Selection of duct heater RH

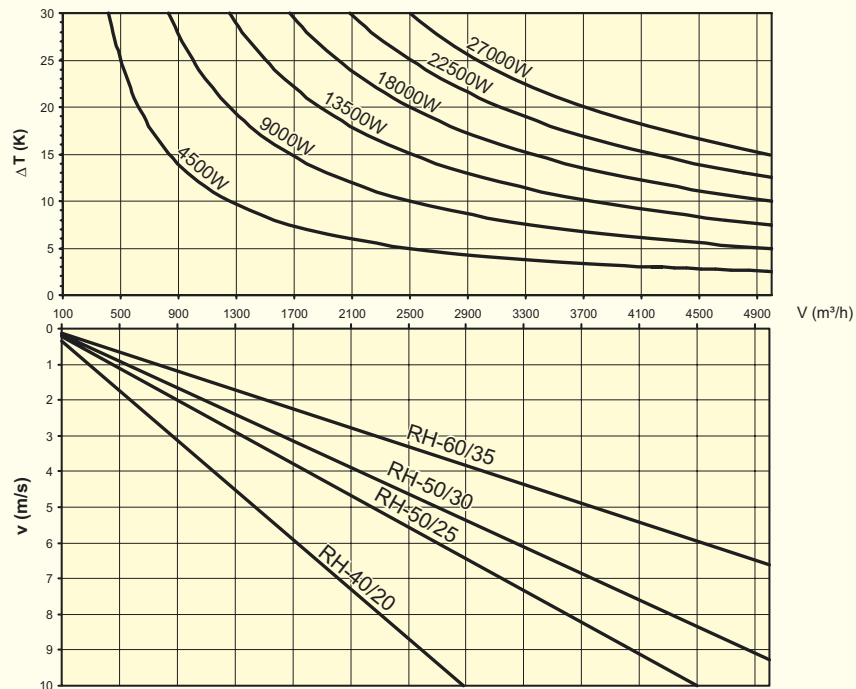

Loss of air pressure through duct heater RH

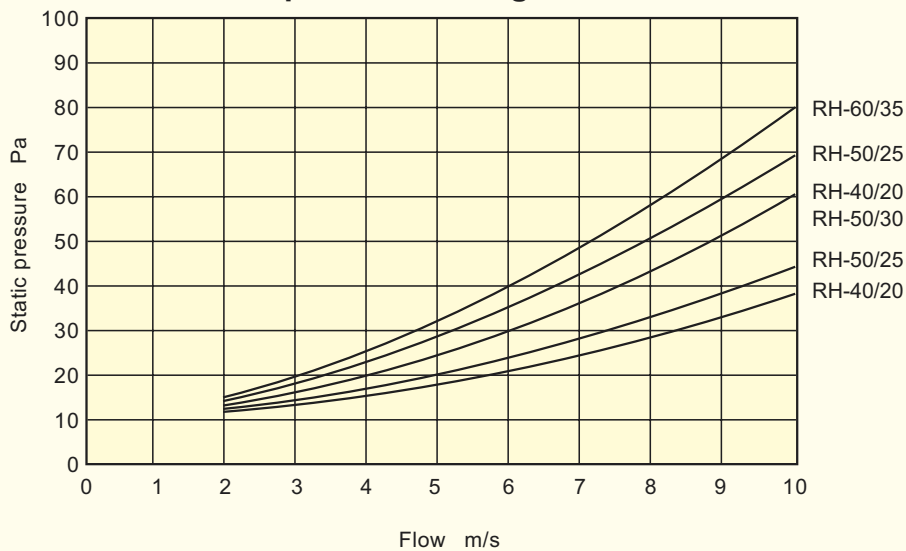

Calculation of power requirement

$$P = Q \cdot 0,36 \cdot \Delta T$$

P - Power [W]

Q - Flow [m³/h]

ΔT - rise in temperature [C]



Silencer for duct systems adapted for IBF.

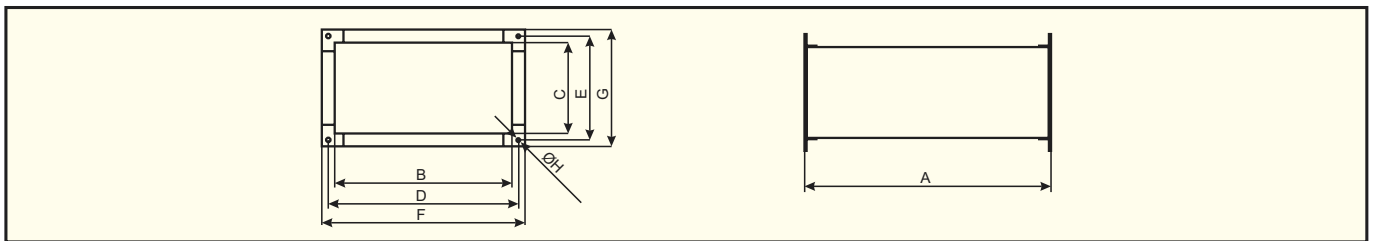

Type	A	B	C	D	E	F	G	ØH	Art. number
RCS-40/20	1000	400	198	440	220	440	240	9	213 985 910
RCS-50/25	1000	500	248	520	270	540	290	9	213 985 920
RCS-50/30	1000	500	298	520	320	540	340	9	213 985 930
RCS-60/30	1000	600	298	620	320	640	340	9	213 985 940
RCS-60/35	1000	600	348	620	370	640	390	9	213 985 950
RCS-70/40	1000	700	398	720	420	740	440	9	213 985 960
RCS-80/50	1000	800	498	820	520	840	540	9	213 985 970
RCS-100/50	1000	1000	498	1020	520	1040	540	9	213 985 980

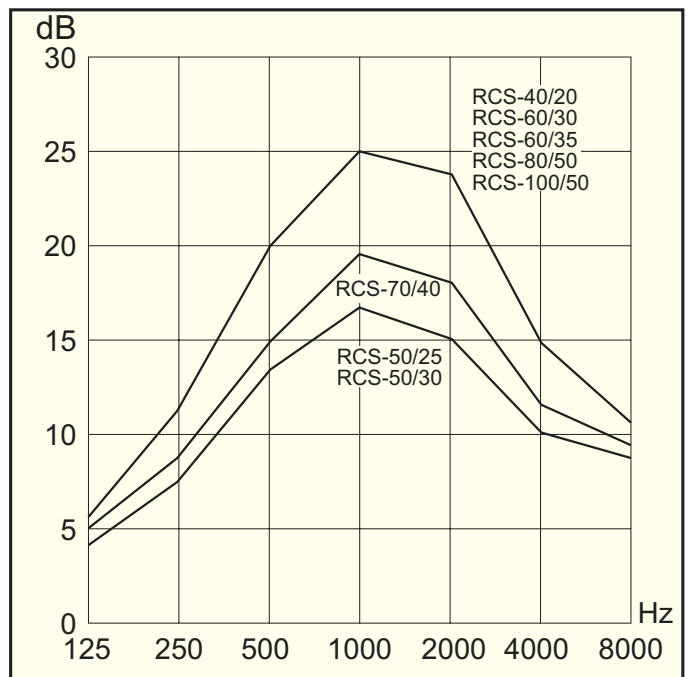
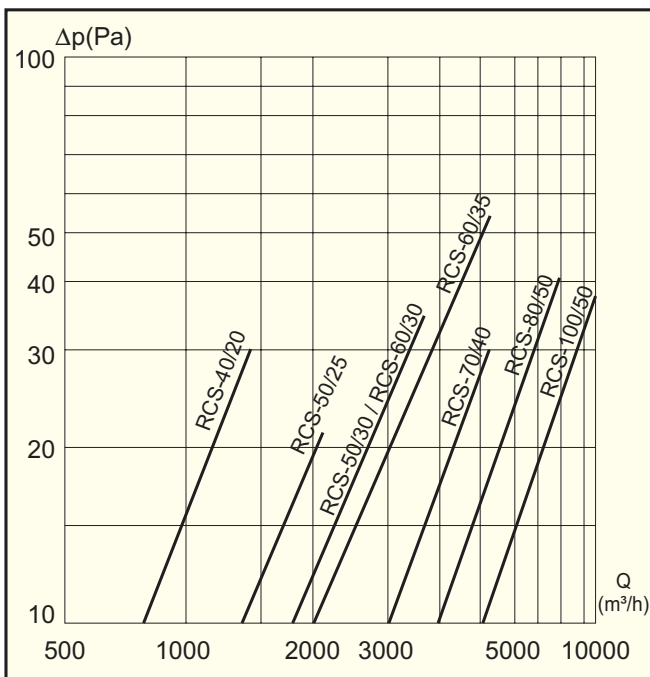



Construction

Duct filter DF adapted to cylindrical ventilation ducts in standard dimensions (100 - 400 mm). Casing in powder coated steel sheet with rubber packed sleeve couplings and closing with clamp lock. Standard RAL9010. Filter insert class EU3. Duct filters in other dimensions, materials, and classes can be delivered on request.

Performance curve

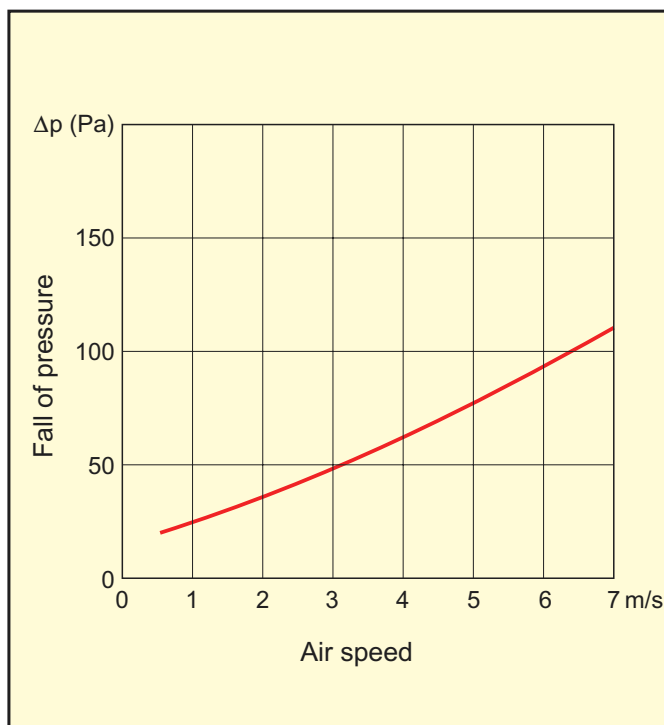

Dimensions in mm

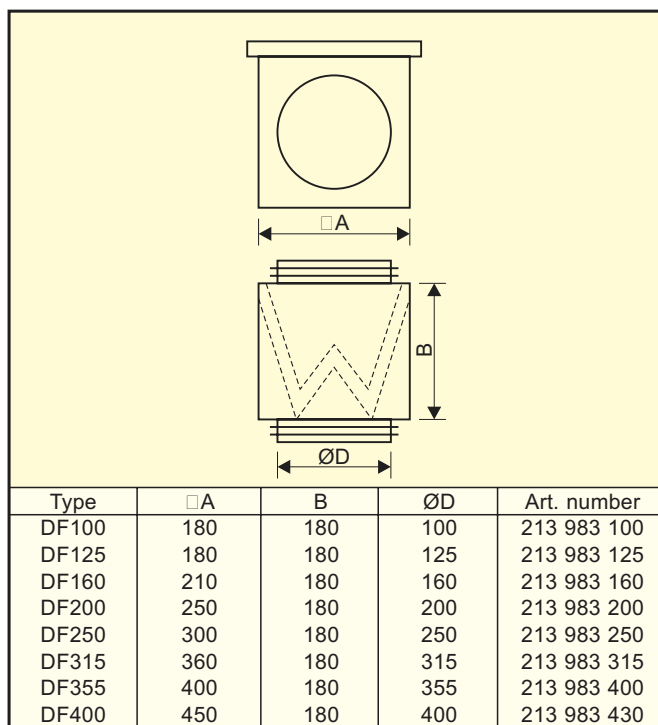



Construction

Duct filter DFK adapted to cylindrical ventilation ducts in standard dimensions (100-560 mm). Casing in powder coated steel sheet with rubber packed sleeve couplings and closing with clamp lock. Standard RAL9010. Bag insert EU3, EU5 or EU7.

Dimensions in mm

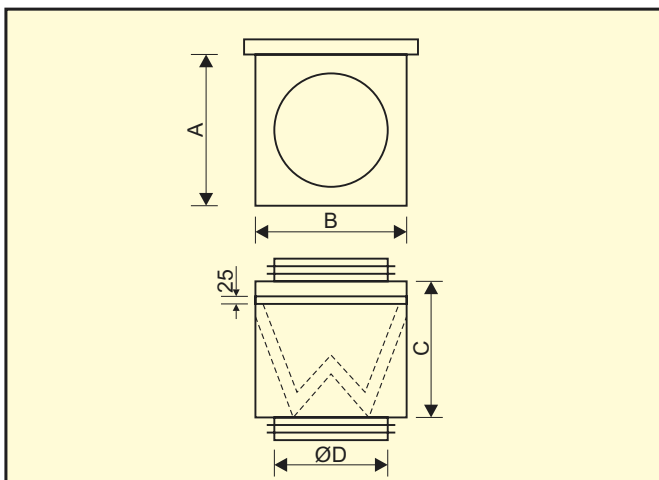

Type	A	B	C	ØD	Art. num.
DF-K 100	290	290	450	100	213983600
DF-K 125	290	290	450	125	213983610
DF-K 160	290	290	450	160	213983620
DF-K 200	290	290	450	200	213983630
DF-K 250	290	290	450	250	213983640
DF-K 315	493	595	600	315	213983650
DF-K 355	493	595	600	355	213983660
DF-K 400	493	595	600	400	213983670
DF-K 450	493	595	600	450	213983680
DF-K 500	595	595	600	500	213983690
DF-K 560	595	595	600	560	213983700

Type	Filter class		
	EU3	EU5	EU7
DF-K 100 ... DF-K 250	213983800	213983805	213983810
DF-K 315 ... DF-K 450	213983830	213983835	213983840
DF-K 500 ... DF-K 560	213983845	213983850	213983855

Performance curves

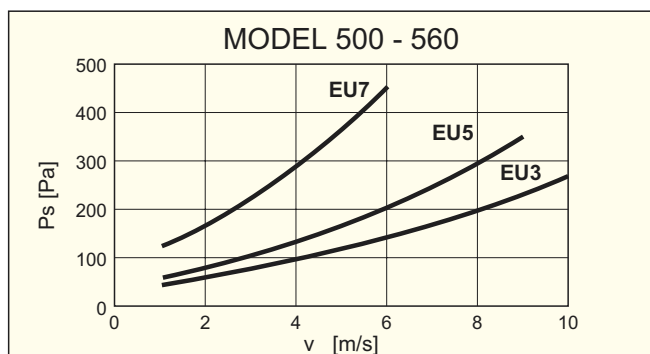
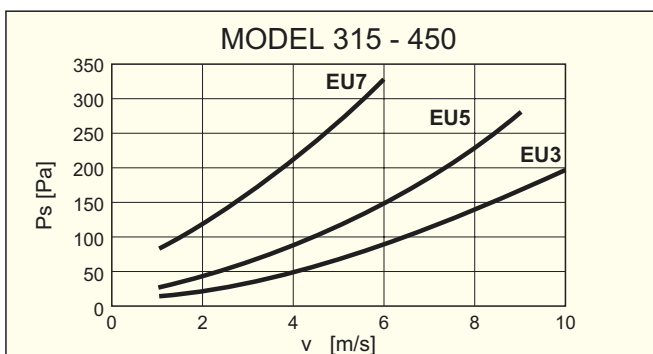
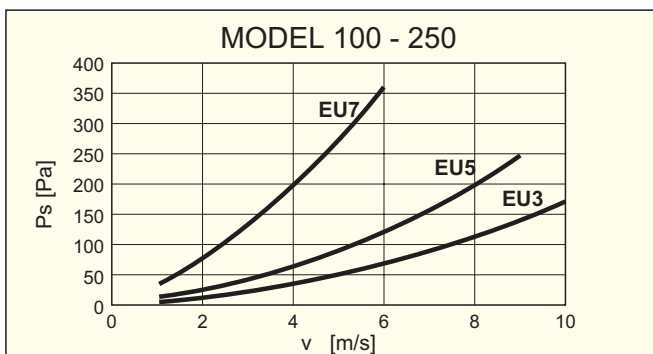

**ACOP PL**

Antivibration coupling for circular ventilation ducts.

Type	Nominal diameter [mm]	Article number
ACOP PL 100	100	112930810
ACOP PL 125	125	112930815
ACOP PL 160	160	112930820
ACOP PL 200	200	112930825
ACOP PL 250	250	112930830
ACOP PL 315	315	112930835
ACOP PL 355	355	112930840
ACOP PL 400	400	112930845

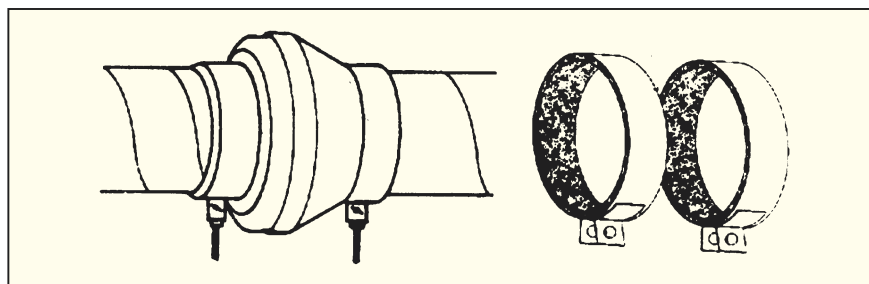

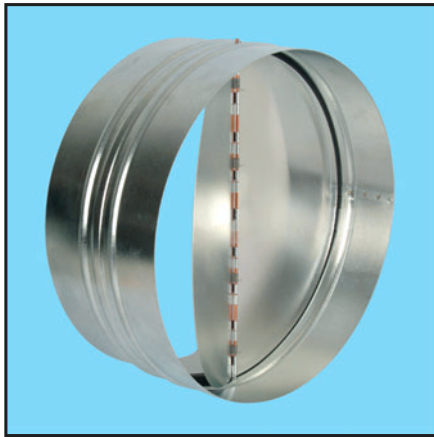

Construction

Backdraught shutters CAR are designed for installation in circular ventilation ducts.

Dimensions in mm

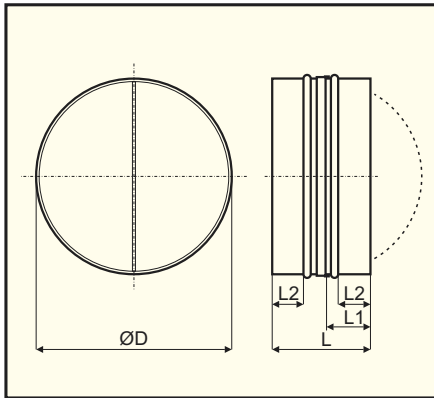

Type	ØD	L	L1	L2	Art. number
CAR-100	100	80	32		112 930 100
CAR-125	125	100	42		112 930 125
CAR-150	150	120	52		112 930 150
CAR-160	160	120	52		112 930 160
CAR-200	200	140	62		112 930 200
CAR-250	250	140	62		112 930 250
CAR-315	315	140	62	45	112 930 315

Performance curves

